

FOR CAR USE ONLY/NUR FÜR AUTOMOBIL GEBRAUCH/POUR APPLICATION AUTOMOBILE UNIQUEMENT/
PARA USO EN AUTOMÓVILES/SOLO PER L'UTILIZZO IN AUTOMOBILE/ENDAST FÖR BILBRUK

ALPINE®

RDS MP3/WMA/AAC CD Receiver

CDA-9887R

MP3



AAC



- **OWNER'S MANUAL**
Please read before using this equipment.
- **BEDIENUNGSANLEITUNG**
Lesen Sie diese Bedienungsanleitung bitte vor Gebrauch des Gerätes.
- **MODE D'EMPLOI**
Veuillez lire avant d'utiliser cet appareil.
- **MANUAL DE OPERACIÓN**
Léalo antes de utilizar este equipo.
- **ISTRUZIONI PER L'USO**
Si prega di leggere prima di utilizzare il attrezzatura.
- **ANVÄNDARHANDLEDNING**
Innan du använder utrustningen bör du läsa igenom denna användarhandledning.

ALPINE ELECTRONICS MARKETING, INC.

1-1-8 Nishi Gotanda,
Shinagawa-ku,
Tokyo 141-0031, Japan
Phone 03-5496-8231

ALPINE ELECTRONICS OF AMERICA, INC.

19145 Gramercy Place, Torrance,
California 90501, U.S.A.
Phone 1-800-ALPINE-1 (1-800-257-4631)

ALPINE ELECTRONICS OF CANADA, INC.

777 Superstest Road, Toronto,
Ontario M3J 2M9, Canada
Phone 1-800-ALPINE-1 (1-800-257-4631)

ALPINE ELECTRONICS OF AUSTRALIA PTY. LTD.

161-165 Princes Highway, Hallam
Victoria 3803, Australia
Phone 03-8787-1200

ALPINE ELECTRONICS GmbH

Frankfurter Ring 117, 80807 München, Germany
Phone 089-32 42 640

ALPINE ELECTRONICS OF U.K. LTD.

Alpine House
Fletchamstead Highway, Coventry CV4 9TW, U.K.
Phone 0870-33 33 763

ALPINE ELECTRONICS FRANCE S.A.R.L.

(RCS PONTOISE B 338 101 280)
98, Rue de la Belle Etoile, Z.I. Paris Nord II,
B.P. 50016, 95945 Roissy Charles de Gaulle
Cedex, France
Phone 01-48638989

ALPINE ITALIA S.p.A.

Viale C. Colombo 8, 20090 Trezzano
Sul Naviglio (MI), Italy
Phone 02-484781

ALPINE ELECTRONICS DE ESPAÑA, S.A.

Portal de Gamarra 36, Pabellón, 32
01013 Vitoria (Alava)-APDO 133, Spain
Phone 945-283588

ALPINE ELECTRONICS (BENELUX) GmbH

Leuvensesteenweg 510-B6,
1930 Zaventem, Belgium
Phone 02-725-13 15

EN

DE

FR

ES

IT

SE

Experience music the way the artist intended

Alpine introduces IMPRINT — the world's first technology that thoroughly eliminates in-car acoustic problems that normally degrade sound quality.



VISION VS. REALITY

All good music starts as an artist's vision. After countless hours of rehearsing, recording and mixing, that vision is ready for us to hear on discs, radio and other media. But do we hear it as the artist created it? Unfortunately, the reality is that we are almost never able to listen to it in the exact way the artist intended. Especially when we are listening in a car.

CARS ARE TERRIBLE LISTENING SPACES

Car interiors are full of materials that obstruct and degrade sound quality. For example, windows amplify and reflect high frequencies. Seat and dashboard coverings change certain frequencies. Carpets absorb and suppress mid frequencies. Graphic and parametric EQs are only partial remedies for these problems. In addition, the speakers are not located at equal distances from listeners, creating an unbalanced, uncentred sound stage. Time correction can help fix this, but only for one listening position.

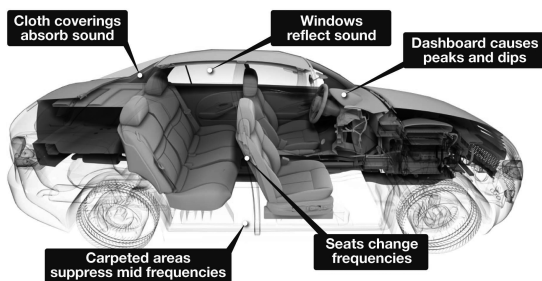

INTRODUCING IMPRINT

These acoustical problems are so severe that no correction system has been able to overcome them. Until now, with the introduction of IMPRINT, Alpine provides a hardware/software combination that not only solves these problems, it actually improves the sound stage, tonal balance and definition — and does it automatically, in a matter of minutes!

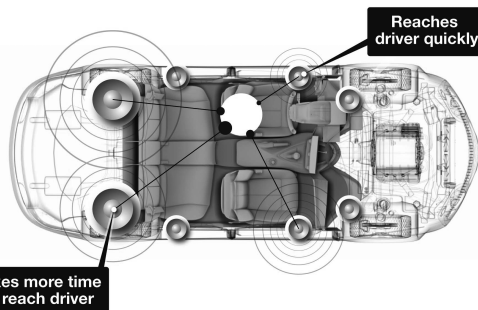

HOW IMPRINT IS DIFFERENT

IMPRINT using MultEQ is superior to other equalisation systems in five ways.

1. It is the only system that measures the entire listening area, capturing time domain information from each listening location and applying a proprietary method for processing it to represent all seat locations. This gives the people in each seat the optimal listening experience.
2. It corrects both time and frequency problems, for an improved soundstage and smoother, more natural sound.
3. It uses dynamic frequency allocation to apply hundreds of points of correction to those areas where the sound problems are greatest.
4. It determines optimised blending points for low frequency crossovers.
5. It provides, in minutes, vehicle sound tuning that generally takes skilled professionals days to accomplish.

Contents

Operating Instructions

WARNING

WARNING	3
CAUTION	3
PRECAUTIONS	3

Getting Started

Accessory List	6
Turning Power On and Off	6
Detaching and Attaching the Front Panel	6
Initial System Start-Up	7
Adjusting Volume	7
Setting the Time and Calendar	7

Radio

Listening to Radio	8
Presetting Stations Manually	8
Presetting Stations Automatically	8
Tuning to Preset Stations	8
Frequency Search Function	8

RDS

Setting RDS Reception Mode and Receiving RDS Stations	9
Recalling Preset RDS Stations	9
Receiving RDS Regional (Local) Stations	9
PI SEEK Setting	10
Setting PTY31 (Emergency Broadcast) reception	10
Setting the Time to automatically Adjust	10
Receiving Traffic Information	10
PTY (Programme Type) Tuning	11
Receiving Traffic Information While Playing CD or Radio	11
Priority News	11
Displaying Radio Text	12

CD/MP3/WMA/AAC

Playback	12
Repeat Play	13
M.I.X. (Random Play)	13
Searching from CD Text	13
File/Folder Name Search (concerning MP3/WMA/AAC)	14
Quick Search	14
About MP3/WMA/AAC	14

Sound Setting

Adjusting Bass/Treble/Balance (Between Left and Right)/Auto Volume/Fader (Between Front and Rear)/Defeat	16
Turning MultEQ on/off	16
Equalizer Presets	16
Setting EQ mode	16
Adjusting and Storing the Parametric Equalizer Curve	17
Adjusting and Storing the Graphic Equalizer Curve	17
Recalling the Stored Equalizer Curve	18
About the Crossover	18
Adjusting and Storing the Crossover Settings	19
Recalling the Stored Crossover Settings	20
About Time Correction	20
Setting the Time Correction Unit	21
Adjusting and Storing the Time Correction	21
Recalling the Stored Time Correction Settings	22
Setting the MX Mode	22

Other Functions

Displaying the Text	23
Displaying Time	24
Blackout Mode On and Off	24

SETUP

Bluetooth Setting

Setting the Bluetooth IN Connection 25

General Setting

Birthday Opening Message Setting
(Birthday Set) 25
Setting the Clock Display (Clock Mode) 25
Turning the Clock Display ON/OFF
(Clock) 25
Playing MP3/WMA/AAC Data
(Play Mode) 25
Sound (Beep) Guide Function 25
Turning Mute Mode On/Off (INT Mute) 25
Setting the AUX+ Setup Mode 25
Setting the AUX Mode (V-Link) 25
Setting the External Digital Input
(Digital AUX) 25
Connecting to an External Amplifier 26
Setting Adaptive Steering Remote Control 26
Setting the Language Font (Language Set) 26
Demonstration 26

Audio Setting

Subwoofer On and Off 27
Setting the Subwoofer System 27
Setting the Filter Type 27
Setting the Subwoofer phase 27
Setting the Subwoofer Output
(SUBW. Channel) 27
Setting the Response Slope for the High Range
Speaker (TW Setup) 27

Display Setting

Changing Lighting Colour (Illumination) 27
Dimmer Control 27
Scroll Type Setting 28
Scroll Setting (Text Scroll) 28
Switching the Character Font (Font Select) 28
Switching the Animation Display Type
(BGV Select) 28
Setting of Calendar Display Pattern Switching
(Calendar)..... 28
Opening Message ON/OFF Setting 28

Tuner Setting

Adjusting Source Signal Levels (FM Level) ... 28

iPod® (Optional)

Playback 29
Searching for a desired Song 29
Quick Search 30
Direct Search Function 30
Select Playlist/Artist/Album/Podcast/Genre/
Composer 30
Random Play Shuffle (M.I.X.) 31
Repeat Play 31
Displaying the Text 31

Changer (Optional)

Controlling CD Changer (Optional) 32
Playing MP3 Files with the CD Changer
(Optional) 32
Multi-Changer Selection (Optional) 32

Remote Control

Controls on Remote Control 33
Operating the Audio Processor 33
Battery Replacement 34

Information

In Case of Difficulty 35
Specifications 37

Installation and Connections

Warning 38
Caution 38
Precautions 38
Installation 39
Connections 40

Operating Instructions

WARNING



WARNING

This symbol means important instructions. Failure to heed them can result in serious injury or death.

DO NOT OPERATE ANY FUNCTION THAT TAKES YOUR ATTENTION AWAY FROM SAFELY DRIVING YOUR VEHICLE.

Any function that requires your prolonged attention should only be performed after coming to a complete stop. Always stop the vehicle in a safe location before performing these functions. Failure to do so may result in an accident.

KEEP THE VOLUME AT A LEVEL WHERE YOU CAN STILL HEAR OUTSIDE NOISES WHILE DRIVING.

Excessive volume levels that obscure sounds such as emergency vehicle sirens or road warning signals (train crossings, etc.) can be dangerous and may result in an accident. LISTENING AT LOUD VOLUME LEVELS IN A CAR MAY ALSO CAUSE HEARING DAMAGE.

DO NOT DISASSEMBLE OR ALTER.

Doing so may result in an accident, fire or electric shock.

USE ONLY IN CARS WITH A 12 VOLT NEGATIVE GROUND.

(Check with your dealer if you are not sure.) Failure to do so may result in fire, etc.

KEEP SMALL OBJECTS SUCH AS BATTERIES OUT OF THE REACH OF CHILDREN.

Swallowing them may result in serious injury. If swallowed, consult a physician immediately.

USE THE CORRECT AMPERE RATING WHEN REPLACING FUSES.

Failure to do so may result in fire or electric shock.

DO NOT BLOCK VENTS OR RADIATOR PANELS.

Doing so may cause heat to build up inside and may result in fire.

USE THIS PRODUCT FOR MOBILE 12V APPLICATIONS.

Use for other than its designed application may result in fire, electric shock or other injury.

DO NOT PLACE HANDS, FINGERS OR FOREIGN OBJECTS IN INSERTION SLOTS OR GAPS.

Doing so may result in personal injury or damage to the product.



CAUTION

This symbol means important instructions. Failure to heed them can result in injury or material property damage.

HALT USE IMMEDIATELY IF A PROBLEM APPEARS.

Failure to do so may cause personal injury or damage to the product. Return it to your authorized Alpine dealer or the nearest Alpine Service Centre for repairing.

DO NOT MIX NEW BATTERIES WITH OLD BATTERIES. INSERT WITH THE CORRECT BATTERY POLARITY.

When inserting the batteries, be sure to observe proper polarity (+ and -) as instructed. Rupture or chemical leakage from the battery may cause fire or personal injury.



PRECAUTIONS

Product Cleaning

Use a soft dry cloth for periodic cleaning of the product. For more severe stains, please dampen the cloth with water only. Anything else has the chance of dissolving the paint or damaging the plastic.

Temperature

Be sure the temperature inside the vehicle is between +60°C (+140°F) and -10°C (+14°F) before turning your unit on.

Moisture Condensation

You may notice the CD playback sound wavering due to condensation. If this happens, remove the disc from the player and wait about an hour for the moisture to evaporate.

Damaged Disc

Do not attempt to play cracked, warped, or damaged discs. Playing a bad disc could severely damage the playback mechanism.

Maintenance

If you have problems, do not attempt to repair the unit yourself. Return it to your Alpine dealer or the nearest Alpine Service Station for servicing.

Never Attempt the Following

Do not grip or pull out the disc while it is being pulled back into the player by the automatic reloading mechanism.

Do not attempt to insert a disc into the unit when the unit power is off.

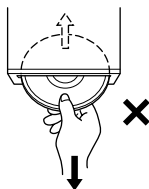

Inserting Discs

Your player accepts only one disc at a time for playback. Do not attempt to load more than one disc.

Make sure the label side is facing up when you insert the disc. "Error" will be displayed on your player if you insert a disc incorrectly. If "Error" continues to be displayed even though the disc has been inserted correctly, push the RESET switch with a pointed object such as a ballpoint pen.

Playing a disc while driving on a very bumpy road may result in skips, but this will not scratch the disc or damage the player.

New Discs

To prevent the CD from jamming, "Error" is displayed if discs with irregular surfaces are inserted or if discs are inserted incorrectly.

When a new disc is ejected immediately after initial loading, use your finger to feel around the inside of the centre hole and outside edge of the disc. If you feel any small bumps or irregularities, this could inhibit proper loading of the disc. To remove the bumps, rub the inside edge of the hole and outside edge of the disc with a ballpoint pen or other such instrument, then insert the disc again.

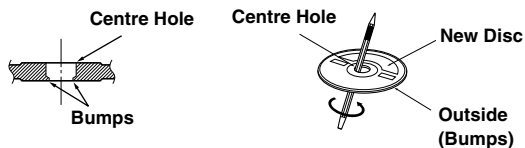

Irregular Shaped Discs

Be sure to use round shape discs only for this unit and never use any special shape discs.

Use of special shape discs may cause damage to the mechanism.



Installation Location

Make sure this unit will not be installed in a location subjected to:

- Direct sun and heat
- High humidity and water
- Excessive dust
- Excessive vibrations

Correct Handling

Do not drop the disc while handling. Hold the disc so you will not leave fingerprints on the surface. Do not affix tape, paper, or gummed labels to the disc. Do not write on the disc.

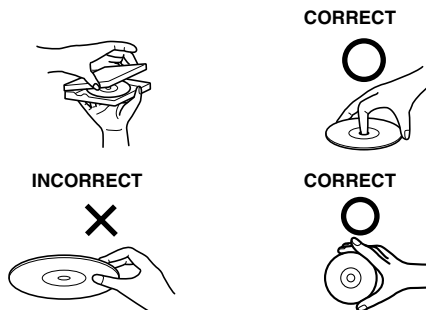

Disc Cleaning

Fingerprints, dust, or soil on the surface of the disc could cause the CD player to skip. For routine cleaning, wipe the playing surface with a clean, soft cloth from the centre of the disc to the outer edge.

If the surface is heavily soiled, dampen a clean, soft cloth in a solution of mild neutral detergent before cleaning the disc.



Disc Accessories

There are various accessories available on the market for protecting the disc surface and improving sound quality. However, most of them will influence the thickness and/or diameter of the disc. Using such accessories can cause the disc to be out of standard specifications and may create operational problems. We recommend not using these accessories on discs played in Alpine CD players.

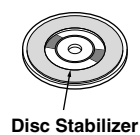
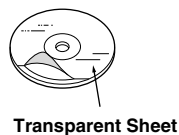

On handling Compact Discs (CD/CD-R/CD-RW)

- Do not touch the surface.
- Do not expose the disc to direct sunlight.
- Do not affix stickers or labels.
- Clean the disc when it is dusty.
- Make sure that there are no bumps around the disc.
- Do not use commercially available disc accessories.

Do not leave the disc in the car or the unit for a long time.
Never expose the disc to direct sunlight. Heat and humidity may damage the CD and you may not be able to play it again.

To customers using CD-R/CD-RW

- If a CD-R/CD-RW cannot be played back, make sure the last recording session was closed (finalized).
- Finalize the CD-R/CD-RW if necessary, and attempt playback again.

About media that can be played

Use only compact discs with the label side showing the CD logo marks below.



If you use unspecified compact discs, correct performance cannot be guaranteed.

You can play CD-Rs (CD-Recordables)/CD-RWs (CD-ReWritables) which have been recorded only on audio devices. You can also play CD-Rs/CD-RWs containing MP3/WMA/AAC formatted audio files.

- Some of the following CDs may not play on this unit:
Flawed CDs, CDs with fingerprints, CDs exposed to extreme temperatures or sunlight (e.g., left in the car or this unit), CDs recorded under unstable conditions, CDs on which a recording failed or a re-recording was attempted, copy-protected CDs which do not conform to the audio CD industry standard.
- Use discs with MP3/WMA/AAC files written in a format compatible with this unit. For details, see pages 14-15.
- ROM data other than audio files contained in a disc will not produce sound when played back.

-
- *Windows Media and the Windows logo are trademarks, or registered trademarks of Microsoft Corporation in the United States and/or other countries.*
 - *Apple, the Apple logo, iPod and iTunes are trademarks of Apple Computer, Inc., registered in the U.S. and other countries.*
 - *“MPEG Layer-3 audio coding technology licensed from Fraunhofer IIS and Thomson.”*
 - *“Supply of this product only conveys a license for private, non-commercial use and does not convey a license nor imply any right to use this product in any commercial (i.e. revenue-generation) real time broadcasting (terrestrial, satellite, cable and/or any other media), broadcasting/streaming via internet, intranets and/or other networks or in other electronic content distribution systems, such as pay-audio or audio-on-demand applications. An independent license for such use is required. For details, please visit <http://www.mp3licensing.com>”*
 - *Manufactured under license from Audyssey Laboratories. MultEQ XT is a trademark of Audyssey Laboratories.*

Getting Started

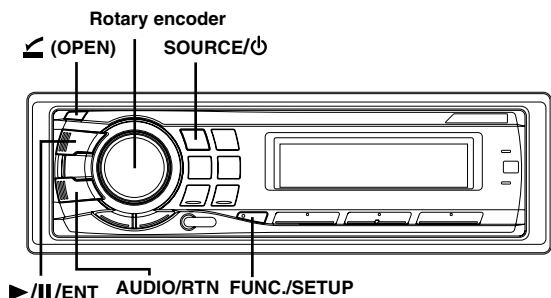

Accessory List

- Head unit 1
- Power cable 1
- Mounting sleeve 1
- Carrying case 1
- Rubber Cap 1
- Hex Bolt 1
- Screw (M5 x 8) 4
- Remote Control 1
- Battery (AAA size) 2
- Owner's Manual 1 set

Turning Power On and Off

Press **SOURCE/⏻** to turn on the unit.

- The unit can be turned on by pressing any other button except **(OPEN)** and Rotary encoder.

Press and hold **SOURCE/⏻** for at least 2 seconds to turn off the unit.

- The first time power is turned on, the volume will start from level 12.

Detaching and Attaching the Front Panel

Be sure to push the Rotary encoder inside the unit before opening the front panel so that the front panel will open completely, otherwise it may be damaged.

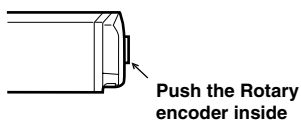

When you push the Rotary encoder again, it pops back out.

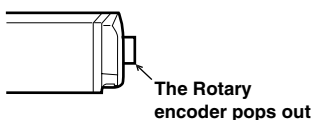

Detaching

- 1 Turn off the unit power.
- 2 Press **(OPEN)** to open the front panel.

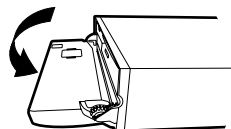

To close the front panel, press the left side until it locks as shown in the figure below.

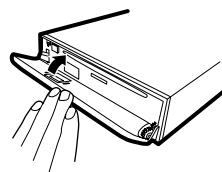

- 3 Grasp the front panel firmly, slide to the left **1**, and then pull **2** to remove.

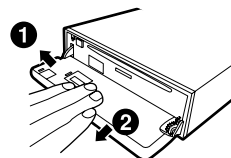

- The front panel may become hot in normal usage (especially the connector terminals on the back of the front panel). This is not a malfunction.
- To protect the front panel, place it in the supplied carrying case.
- When detaching the front panel, do not apply excessive force as it may result in malfunction and damages.
- Do not leave the front panel open, or drive the car with the panel open as it may result in an accident or malfunction.

Attaching

- 1 Insert the right side of the front panel into the main unit. Align the groove on the front panel with the projections on the main unit.
- 2 Push the left side of the front panel until it locks firmly into the main unit.

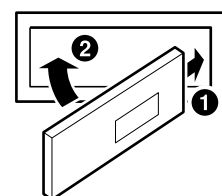

- Before attaching the front panel, make sure that there is no dirt or dust on the connector terminals and no foreign object between the front panel and the main unit.
- Attach the front panel carefully, holding the sides of the front panel to avoid pushing buttons by mistake.

Initial System Start-Up

Be sure to press the RESET switch when using the unit for the first time, after changing the car battery, etc.

- 1 Turn off the unit power.
- 2 Press **⏏ (OPEN)** to open the front panel, and then remove it.
- 3 Press **RESET** with a ballpoint pen or similar pointed object.

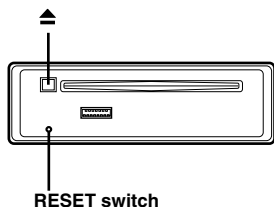

Adjusting Volume

Turn the **Rotary encoder** until the desired sound is obtained.

Setting the Time and Calendar

- 1 Press and hold **FUNC./SETUP** for at least 2 seconds to activate the **SETUP** selection mode.
 - 2 Turn the **Rotary encoder** to select the **GENERAL** mode, and then press **▶/||/ENT**.
Bluetooth ↔ GENERAL ↔ AUDIO ↔ DISPLAY ↔
TUNER ↔ Bluetooth
 - 3 Turn the **Rotary encoder** to select **Clock Adjust**, and then press **▶/||/ENT**.
 - 4 Turn the **Rotary encoder** to set year.
 - 5 Press **▶/||/ENT**.
 - 6 Repeat steps 4 and 5 above to set month, day, hour and minute.
 - 7 Press and hold **FUNC./SETUP** for at least 2 seconds to return to normal mode.
- Pressing **AUDIO/RTN** returns to the previous **SETUP** mode.
 - If no operation is performed for 60 seconds, **SETUP** is cancelled.
 - To synchronize the clock to another clock/watch or radio time announcement, press and hold **▶/||/ENT** for at least 2 seconds after setting the "hour". Minutes will reset to 00. If the display shows over "30" minutes when you do this, the time will advance one hour.

Radio

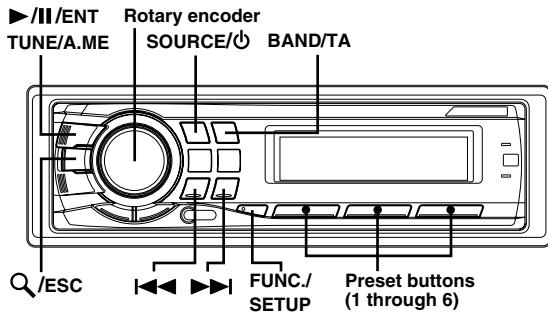

Listening to Radio

- 1 Press **SOURCE/⏻** to select the **TUNER** mode.
 - 2 Press **BAND/TA** repeatedly until the desired radio band is displayed.
FM1 → FM2 → FM3 → MW → LW → FM1
 - 3 Press **TUNE/A.ME** to select the tuning mode.
DX (Distance mode) → LOCAL (Local mode) → MANUAL (Manual mode) → DX (Distance mode)
- The initial mode is Distance mode.

Distance mode:

Both strong and weak stations will be automatically tuned in (Automatic Seek Tuning).

Local mode:

Only strong stations will be automatically tuned in (Automatic Seek Tuning).

Manual mode:

The frequency is manually tuned in steps (Manual tuning).

- 4 Press **◀◀** or **▶▶** to tune in the desired station.
Holding down **◀◀** or **▶▶** will change the frequency continuously.

Presetting Stations Manually

- 1 Select the radio band and tune in a desired radio station you wish to store in the preset memory.
 - 2 Press and hold, for at least 2 seconds, any one of the **preset buttons (1 through 6)** into which you wish to store the station.
The selected station is stored.
The display shows the band, preset number and station frequency memorized.
- A total of 30 stations can be stored in the preset memory (6 stations for each band; FM1, FM2, FM3, MW and LW).
 - If you store a station in a preset memory which already has a station, the current station will be cleared and replaced with the new station.
 - If the function mode is activated, press **FUNC./SETUP** to return to preset mode.

Presetting Stations Automatically

- 1 Press **BAND/TA** repeatedly until the desired radio band is displayed.
 - 2 Press and hold **TUNE/A.ME** for at least 2 seconds.
The frequency on the display continues to change while the automatic memory is in progress. The tuner will automatically seek and store 6 strong stations in the selected band. They will be stored into preset buttons 1 to 6 in order of signal strength.
When the automatic memory has been completed, the tuner goes to the station stored in preset location No. 1.
- If no stations are stored, the tuner will return to the original station you were listening to before the auto memory procedure began.

Tuning to Preset Stations

- 1 Press **BAND/TA** repeatedly until the desired band is displayed.
 - 2 Press any one of the station **preset buttons (1 through 6)** that has your desired radio station in memory.
The display shows the band, preset number and frequency of the station selected.
- If the function mode is activated, press **FUNC./SETUP** to return to preset mode.

Frequency Search Function

You can search for a radio station by its frequency.

- 1 Press and hold **Q/ESC** for at least 2 seconds in **Radio mode** to activate **Frequency search mode**.
 - 2 Turn the **Rotary encoder** to select the desired frequency.
 - 3 Press **▶/II/ENT** to receive the selected frequency.
- Press and hold **Q/ESC** for at least 2 seconds in the search mode to cancel. Or, the search mode will be cancelled if no operation is performed for 10 seconds.

RDS

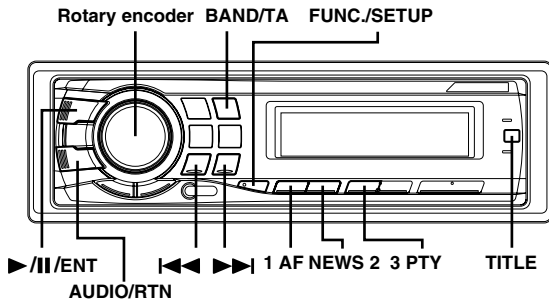

Setting RDS Reception Mode and Receiving RDS Stations

The RDS (Radio Data System) is a radio information system using the 57 kHz subcarrier of regular FM broadcast. The RDS allows you to receive a variety of information such as traffic information, station names, and to automatically re-tune to a stronger transmitter that is broadcasting the same programme.

- 1 Press **FUNC./SETUP** to activate the function mode.
- 2 Press **1 AF** to activate the RDS mode.
- 3 Press **◀◀** or **▶▶** to tune in the desired RDS station.
- 4 Press **1 AF** again to deactivate the RDS mode.
- 5 Press **FUNC./SETUP** to activate the preset mode.

- When the “Setting PTY31 (Emergency Broadcast) reception” (refer to page 10) is set to on, if the unit receives the PTY31 (Emergency Broadcast) signal, the unit will show “ALARM” in the display automatically.
- Operate the unit while the function mode is activated. If no operation is performed for 10 seconds, the function mode is cancelled.

The RDS digital data includes the following:

PI	Programme Identification
PS	Programme Service Name
AF	List of Alternative Frequencies
TP	Traffic Programme
TA	Traffic Announcement
PTY	Programme Type
EON	Enhanced Other Networks

Recalling Preset RDS Stations

- 1 Press **FUNC./SETUP** to activate the function mode.
- 2 Press **1 AF** to activate the RDS mode.
- 3 Press **FUNC./SETUP** to activate the preset mode.
- 4 Make sure that the function mode returns to preset mode, and then press the preset button in which your desired RDS station is preset.
If the preset station's signal is weak, the unit automatically searches and tunes to a stronger station in the AF (Alternative Frequencies) list.
- 5 If the preset station and the stations in the AF list cannot be received:

When the PI SEEK setting is on (refer to “PI SEEK Setting” on page 10), the unit searches again for a station in the PI (Programme Identification) list.

If there are still no stations receivable in the area, the unit displays the frequency of the preset station and the preset No. disappears.

If the signal level of the Regional (Local) station being tuned becomes too weak to receive, press the same preset button to tune in a Regional station in other district.

- For presetting the RDS stations, refer to the Radio Operation section. The RDS stations can be preset in the FM1, FM2 and FM3 bands only.
- Operate the unit while the function mode is activated. If no operation is performed for 10 seconds, the audio function is cancelled.

Receiving RDS Regional (Local) Stations

- 1 Press and hold **FUNC./SETUP** for at least 2 seconds to activate the SETUP mode.
- 2 Turn the **Rotary encoder** to select the TUNER mode, and then press **▶/II/ENT**.
Bluetooth ↔ GENERAL ↔ AUDIO ↔ DISPLAY ↔
TUNER ↔ Bluetooth
- 3 Turn the **Rotary encoder** to select RDS Regional, and then press **▶/II/ENT**.
- 4 Turn the **Rotary encoder** to select ON or OFF.
In the OFF mode, the unit automatically keeps receiving the related local RDS station.
- 5 Press and hold **FUNC./SETUP** for at least 2 seconds to return to normal mode.

- Pressing **AUDIO/RTN** during the procedure will return to the previous mode.
- If no operation is performed for 60 seconds in the SETUP mode, the setting mode is cancelled.

PI SEEK Setting

- 1 Press and hold **FUNC./SETUP** for at least 2 seconds to activate the **SETUP** mode.
- 2 Turn the **Rotary encoder** to select the **TUNER** mode, and then press **►/II/ENT**.
Bluetooth ↔ GENERAL ↔ AUDIO ↔ DISPLAY ↔ TUNER ↔ Bluetooth
- 3 Turn the **Rotary encoder** to select **PI Seek**, and then press **►/II/ENT**.
- 4 Turn the **Rotary encoder** to select **ON** or **OFF**.
- 5 Press and hold **FUNC./SETUP** for at least 2 seconds to return to normal mode.

- Pressing **AUDIO/RTN** during the procedure will return to the previous mode.
- If no operation is performed for 60 seconds in the **SETUP** mode, the setting mode is cancelled.

Setting PTY31 (Emergency Broadcast) reception

Turn PTY31 (Emergency Broadcast) reception ON/OFF.

- 1 Press and hold **FUNC./SETUP** for at least 2 seconds to activate the **SETUP** mode.
- 2 Turn the **Rotary encoder** to select the **TUNER** mode, and then press **►/II/ENT**.
Bluetooth ↔ GENERAL ↔ AUDIO ↔ DISPLAY ↔ TUNER ↔ Bluetooth
- 3 Turn the **Rotary encoder** to select **Alert PTY31**, and then press **►/II/ENT**.
- 4 Turn the **Rotary encoder** to select **ON** or **OFF**.
If you set to **ON**, emergency broadcasts are received regardless of source. "ALARM" is displayed during reception.
- 5 Press and hold **FUNC./SETUP** for at least 2 seconds to return to normal mode.

When an emergency broadcast is received, the volume level will be automatically changed to the memorized level in the traffic information mode. For details, refer to "Receiving Traffic Information" on page 10.

- Pressing **AUDIO/RTN** during the procedure will return to the previous mode.
- If no operation is performed for 60 seconds in the **SETUP** mode, the setting mode is cancelled.

Setting the Time to automatically Adjust

When you set to **ON**, the time is automatically adjusted by RDS data.

- 1 Press and hold **FUNC./SETUP** for at least 2 seconds to activate the **SETUP** mode.
- 2 Turn the **Rotary encoder** to select the **TUNER** mode, and then press **►/II/ENT**.
Bluetooth ↔ GENERAL ↔ AUDIO ↔ DISPLAY ↔ TUNER ↔ Bluetooth
- 3 Turn the **Rotary encoder** to select **Auto Clock**, and then press **►/II/ENT**.
- 4 Turn the **Rotary encoder** to select **ON** or **OFF**.
- 5 Press and hold **FUNC./SETUP** for at least 2 seconds to return to normal mode.

- Pressing **AUDIO/RTN** during the procedure will return to the previous mode.
- If no operation is performed for 60 seconds in the **SETUP** mode, the setting mode is cancelled.

Receiving Traffic Information

- 1 Press and hold **BAND/TA** for at least 2 seconds so that the "TA" indicator lights up.
- 2 Press **◀◀** or **▶▶** to select your desired traffic information station.

When a traffic information station is tuned in, the "TP" indicator lights up.

Traffic information is heard only when it is being broadcast. If traffic information is not being broadcast, the unit is set in the standby mode. When a traffic information broadcast begins, the unit automatically receives it and the display shows "T. INFO".

When the traffic information broadcast is over, the unit will automatically set in the standby mode.

- If the traffic information broadcast signal falls below a certain level, the unit remains in the receiving mode for 1 minute. If the signal remains below a certain level for over 1 minute, the "TA" indicator blinks.
- If you do not want to listen to the traffic information being received, lightly press **BAND/TA** to skip that traffic information message. The **TA** mode will remain in the **ON** position to receive the next traffic information message.
- If the volume level is changed while receiving traffic information, the changed volume level will be memorized. When traffic information is received next time, the volume level will be automatically adjusted to the memorized one if it is within the range 5 to 20. Otherwise, the volume level will be automatically adjusted to 5 (memorized level is below 5) or 20 (memorized level is above 20).
- In the **TA** mode, the **SEEK** tuning selects only the **TP** stations.

PTY (Programme Type) Tuning

1 Press FUNC./SETUP to activate the function mode.

2 Press 3 PTY to activate the PTY mode, while the unit is in Radio (FM receiving) mode.

The Programme Type of the station being currently received will be displayed for 10 seconds.

If there is no receivable PTY broadcast, "NO PTY" will be displayed for 10 seconds.

If no RDS station can be received, the display shows "NO PTY".

- If no operation is performed for 10 seconds after pressing 3 PTY, the PTY mode will be automatically cancelled.

3 Press ◀◀ or ▶▶ within 10 seconds after activating the PTY mode to choose the desired programme type while the PTY (programme type) is being displayed.

Each press scrolls the programme type by one.

4 Press 3 PTY within 10 seconds after selecting the programme type to start searching for a station in the selected programme type.

The chosen programme type display blinks during searching and lights when a station is found.

If no PTY station is found, "NO PTY" will be displayed for 10 seconds.

5 Press FUNC./SETUP to activate the preset mode.

- Operate the unit while the function mode is activated. If no operation is performed for 10 seconds, the function mode is cancelled.

Receiving Traffic Information While Playing CD or Radio

1 Press and hold BAND/TA for at least 2 seconds so that the "TA" indicator lights up.

2 Press ◀◀ or ▶▶ to select a traffic information station if necessary.

When a traffic information broadcast starts, the unit automatically mutes the CD player/changer or the regular FM broadcast.

When the traffic information broadcast finishes, the unit automatically returns to the original source play before the traffic information broadcast began.

When traffic information stations cannot be received:

In the tuner mode:

When the TP signal can no longer be received for over 1 minute, the "TA" indicator blinks.

In the CD mode:

When the TP signal can no longer be received, the traffic information station of another frequency will be selected automatically.

- The receiver is equipped with the EON (Enhanced Other Networks) function in order to keep track of additional alternate frequencies to the AF list. The "EON" indicator lights up while an RDS EON station is being received. If the station being received does not broadcast the traffic information, the receiver automatically tunes in the related station that broadcasts the traffic information when it occurs.

3 Press and hold BAND/TA for at least 2 seconds to deactivate the Traffic Information mode.

The "TA" indicator goes out.

Priority News

This function allows you to preset to give priority to the News programme. You will never miss the News programme as the unit automatically gives priority to the News programme whenever it begins broadcasting, and interrupts the programme you are currently listening. This feature is functional when your unit is set to a mode other than the LW and MW modes.

1 Press FUNC./SETUP to activate the function mode while the unit is in Radio (FM receiving) mode.

2 Press NEWS 2 to activate the PRIORITY NEWS mode.

The "NEWS" indicator appears in the display.

To disable the PRIORITY NEWS function, press NEWS 2.

- In the PRIORITY NEWS function, unlike in the TA function, the volume does not increase automatically.

3 Press FUNC./SETUP to activate the preset mode, while the unit is in Radio (FM receiving) mode.

- Operate the unit while the function mode is activated. If no operation is performed for 10 seconds, the function mode is cancelled.

Displaying Radio Text

Text messages from a radio station can be displayed.

Press **TITLE** while receiving FM in the radio mode to select the Radio Text display.

The display will change every time the button is pressed.

If there is PS (Programme Service Name)

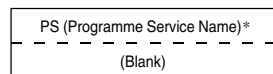
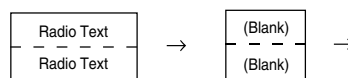
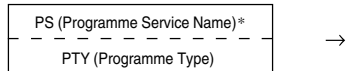
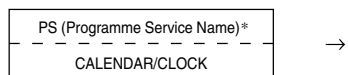
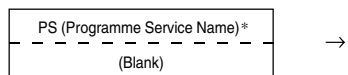

* Press and hold **TITLE** for at least 2 seconds if PS is displayed in the radio mode, frequency will be displayed for 5 seconds.

If there is no PS (Programme Service Name)

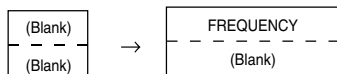
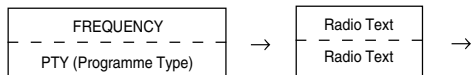
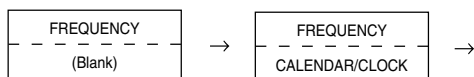

• If there is no receivable text information or the unit cannot receive text information properly, nothing will be displayed.

CD/MP3/WMA/AAC

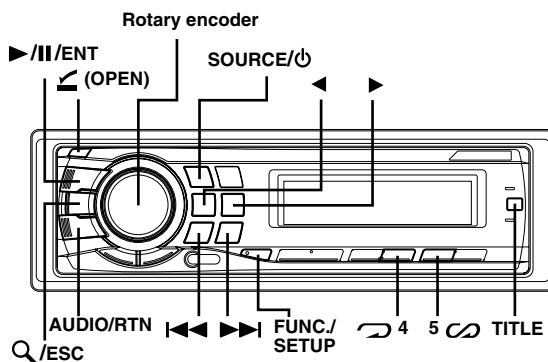

Playback

- 1 Press **(OPEN)**.
The front panel will open.
- 2 Insert a disc with the label side facing up.
The disc will be pulled into the unit automatically.

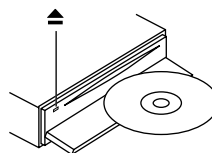

Close the front panel manually.
When a disc is already inserted, press **SOURCE/⏻** to switch to the DISC mode.

The mode will change every time the button is pressed.
TUNER → DISC → iPod*¹ → CHANGER*² → TUNER

*¹ Only when the iPod is connected.
*² Only when the CD changer is connected.

- 3 While playing back MP3/WMA/AAC, press **< or >** to select the desired folder.
Pressing and holding **< or >** will change folders continuously.
- 4 Press **<<< or >>>** to select the desired track (file).

Returning to the beginning of the current track (file):
Press **<<<**.

Fast backward:
Press and hold **<<<**.

Advancing to the beginning of the next track (file):
Press **>>>**.

Fast forward:
Press and hold **>>>**.

- 5 To pause playback, press **>/||/ENT**.
Pressing **>/||/ENT** again will resume playback.

- 6 After pressing **(OPEN)** to open the front panel, press **⏻** to eject the disc.

- Do not remove a CD during its eject cycle. Do not load more than one disc at a time. A malfunction may result from doing either.
- If the CD does not eject, press and hold **▲** for at least 2 seconds.
- The CD-player can play discs containing audio data, MP3 data, WMA data and AAC data.
- WMA format files that are protected by DRM (Digital Rights Management), AAC format files that have been purchased from iTunes Music Store and files that are copy-protected (copyright protection) cannot be played back on this unit.
- The track display for MP3/WMA/AAC data playback is the file numbers recorded on the disc.
- The playback time may not be correctly displayed when a VBR (Variable Bit Rate) recorded file is played back.

MP3/WMA/AAC Play Display

The folder number and file number will be displayed as described below.

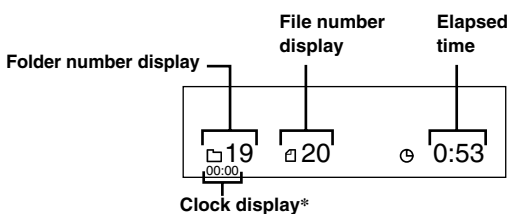

* Displayed when "Turning the Clock Display ON/OFF (Clock)" (page 25) is set to ON.

- Press **TITLE** to switch the display. See "Displaying the Text" (page 23) for information about display switching.

Repeat Play

Press **↶ 4** to play back repeatedly the track being played.

The track (file) will be played repeatedly.

Press **↶ 4** again and select off to deactivate repeat play.

CD mode :

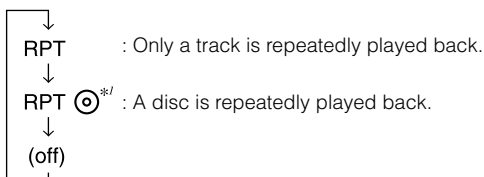

*¹ When a CD changer is connected.

- If RPT is set to ON during M.I.X. play in CD changer mode, M.I.X. will apply to the current disc only.

MP3/WMA/AAC mode :

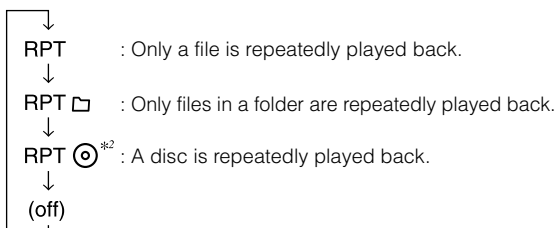

*² When an MP3 compatible CD changer is connected.

- If a CD changer or an MP3 compatible CD changer is connected: After pressing **FUNC./SETUP** to select the function mode (RPT/M.I.X.), perform the operation within 10 seconds.

M.I.X. (Random Play)

Press **5** **↻** in the play or pause mode.

The tracks (files) on the disc will be played back in random sequence.

To cancel M.I.X. play, press **5** **↻** again.

CD mode :

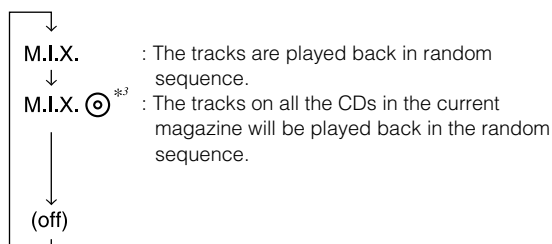

*³ When a CD changer equipped with the ALL M.I.X. function is connected.

- If M.I.X. is set to ON during RPT **☉** (REPEAT ALL) play in CD changer mode, M.I.X. will apply to the current disc only.

MP3/WMA/AAC mode :

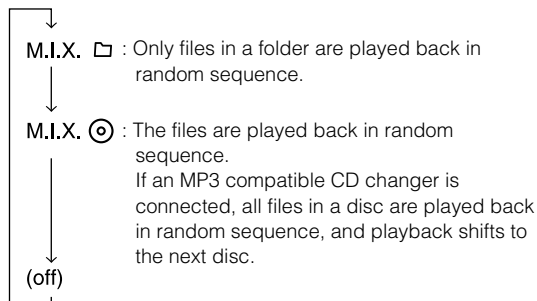

- If a CD changer or an MP3 compatible CD changer is connected: After pressing **FUNC./SETUP** to select the function mode (RPT/M.I.X.), perform the operation within 10 seconds.

Searching from CD Text

Tracks can be searched and played by using the CD text on the disc. If a disc is not compatible with text, or a disc is in the changer, searches can be made by track number.

1 Press **Q/ESC** during play.

This will set the search mode.

2 Turn the **Rotary encoder** to select the desired track, and then press **▶/II/ENT**.

This will play the selected track.

- Press and hold **Q/ESC** for at least 2 seconds in the search mode to cancel. Or, the search mode is cancelled if no operation is performed for 10 seconds.
- CD text search cannot be made during M.I.X. play.

File/Folder Name Search (concerning MP3/WMA/AAC)

Folder and file names may be searched and displayed during playback.

- 1 Press **Q/ESC** to activate **Search selection mode** during **MP3/WMA/AAC** playback.
 - 2 Turn the **Rotary encoder** to select **Folder Name Search mode** or **File Name Search mode**, and then press **▶/||/ENT**.
-

Folder Name Search mode

- 3 Turn the **Rotary encoder** to select the desired folder.
 - 4 Press and hold **▶/||/ENT** for at least 2 seconds to play back the first file in the selected folder.
- Press and hold **Q/ESC** for at least 2 seconds in the search mode to cancel. Or, the search mode is cancelled if no operation is performed for 10 seconds.
 - To search for files in the Folder Name Search mode, press **▶/||/ENT**. Files in the folder may be searched.
 - Press **AUDIO/RTN** to exit Folder Name Search mode in step 3 in order to select File Name Search mode.
 - The root folder is displayed as "ROOT".
 - Folder Name Search cannot be made during *M.I.X.* play.

File Name Search mode

- 3 Press **◀** or **▶** to select another Folder.
 - 4 Select the desired file by turning the **Rotary encoder**.
 - 5 Press **▶/||/ENT** to play back the selected file.
- Press and hold **Q/ESC** for at least 2 seconds in the search mode to cancel. Or, the search mode is cancelled if no operation is performed for 10 seconds.
 - Press **AUDIO/RTN** in the search mode to return to the previous mode.
 - File Name Search cannot be made during *M.I.X.* play.

Quick Search

You can search for tracks (files).

- 1 Press and hold **Q/ESC** for at least 2 seconds in the **CD/Changer/MP3/WMA/AAC mode** to activate **Quick Search mode**.
 - 2 Turn the **Rotary encoder** to select a desired track (file).
The selected track is played back immediately.
- Press and hold **Q/ESC** for at least 2 seconds in the search mode to cancel. Or, the search mode is cancelled if no operation is performed for 10 seconds.

About MP3/WMA/AAC

CAUTION

Except for private use, duplicating audio data (including MP3/WMA/AAC data) or distributing, transferring, or copying it, whether for free or for a fee, without permission of the copyright holder is strictly prohibited by the Copyright Act and by international treaty.

What is MP3?

MP3, whose official name is "MPEG-1 Audio Layer 3," is a compression standard prescribed by the ISO, the International Standardization Organization and MPEG which is a joint activity institution of the IEC.

MP3 files contain compressed audio data. MP3 encoding is capable of compressing audio data at extremely high ratios, reducing the size of music files to as much as one-tenth their original size. This is achieved while still maintaining near CD quality. The MP3 format realises such high compression ratios by eliminating the sounds that are either inaudible to the human ear or masked by other sounds.

What is AAC?

AAC is the abbreviation for "Advanced Audio Coding", and is a basic format of audio compression used by MPEG2 or MPEG4.

What is WMA?

WMA, or "Windows Media™ Audio," is compressed audio data. WMA is similar to MP3 audio data and can achieve CD quality sound with small file sizes.

Method for creating MP3/WMA/AAC files

Audio data is compressed using software with MP3/WMA/AAC codecs. For details on creating MP3/WMA/AAC files, refer to the user's manual for that software.

MP3/WMA/AAC files that can be played back by this device have the following file extensions:

MP3: ".mp3"

WMA: ".wma" (ver. 7.1, 8 and 9 are supported)

AAC: ".m4a"

There are many different versions of the AAC format. Confirm that the software being used conforms to the acceptable formats listed above. It's possible that the format may be unplayable even though the extension is valid. Playback of AAC files encoded by iTunes version 7.0 or earlier is supported.

Supported playback sampling rates and bit rates

MP3

Sampling rates: 48 kHz, 44.1 kHz, 32 kHz, 24 kHz, 22.05 kHz, 16 kHz, 12 kHz, 11.025 kHz, 8 kHz

Bit rates: 8 - 320 kbps

WMA

Sampling rates: 48 kHz, 44.1 kHz, 32 kHz

Bit rates: 48 - 192 kbps

AAC

Sampling rates: 48 kHz, 44.1 kHz, 32 kHz, 24 kHz, 22.05 kHz, 16 kHz, 12 kHz, 11.025 kHz, 8 kHz

Bit rates: 16 - 320 kbps

This device may not play back correctly depending on sampling rates.

ID3 tags/WMA tags

This device supports ID3 tag v1 and v2, and WMA tag. If tag data is in an MP3/WMA/AAC file, this device can display the title (track title), artist name, and album name ID3 tag/WMA tag data.

This device can only display single-byte alphanumeric characters (up to 30 for ID3 tags and up to 15 for WMA tags) and the underscore. For non-supported characters, the display is blank.

The tag information may not be correctly displayed, depending on the contents.

Producing MP3/WMA/AAC discs

MP3/WMA/AAC files are prepared, then written to a CD-R or CD-RW using CD-R writing software. A disc can hold up to 510 files/folders (including Root Folders), and the maximum number of folders is 255.

Playback may not be performed if a disc exceeds the limitations described above.

Media supported

The media that this device can play back are CD-ROMs, CD-Rs, and CD-RWs.

Corresponding File Systems

This device supports discs formatted with ISO9660 Level 1 or Level 2.

Under the ISO9660 standard, there are some restrictions to remember.

The maximum nested folder depth is 8 (including the root directory). The number of characters for a folder/file name is limited.

Valid characters for folder/file names are letters A-Z (all caps), numbers 0-9, and '_' (underscore).

This device also can play back discs in Joliet, Romeo, etc., and other standards that conform to ISO9660. However, sometimes the file names, folder names, etc., are not displayed correctly.

Formats supported

This device supports CD-ROM XA, Mixed Mode CD, Enhanced CD (CD-Extra) and Multi-Session.

This device cannot correctly play back discs recorded with Track At Once or packet writing.

Order of files

Files are played back in the order that the writing software writes them to the disc. Therefore, the playback order may not be what is expected. Verify the writing order in the software's documentation. The playback order of the folders and files is as follows.

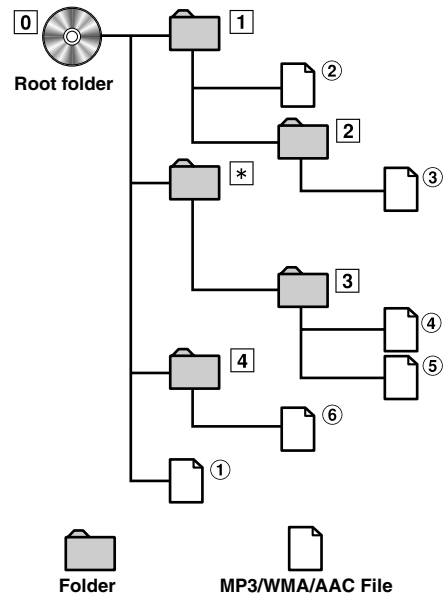

* The folder No./folder Name will not be displayed if no file is contained in the folder.

Terminology

Bit rate

This is the "sound" compression rate specified for encoding. The higher the bit rate, the higher the sound quality, but also the larger the files.

Sampling rate

This value shows how many times per second the data is sampled (recorded). For example, music CDs use a sampling rate of 44.1 kHz, so the sound is sampled (recorded) 44,100 times per second. The higher the sampling rate, the higher the sound quality, but also the larger the volume of data.

Encoding

Converting music CDs, WAVE (AIFF) files, and other sound files into the specified audio compression format.

Tag

Song information such as track titles, artist names, album names, etc., written into MP3/WMA/AAC files.

Root folder

The root folder (or root directory) is found at the top of the file system. The root folder contains all folders and files. It is created automatically for all burned discs.

Sound Setting

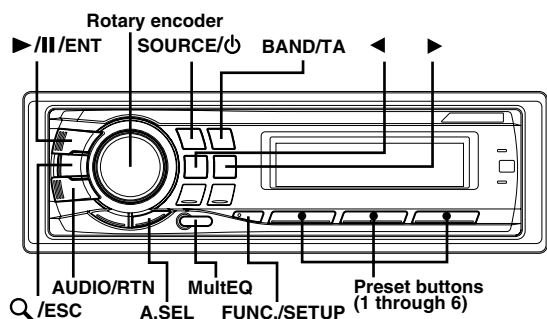

Adjusting Bass/Treble/Balance (Between Left and Right)/Auto Volume/Fader (Between Front and Rear)/Defeat

- 1 Press **AUDIO/RTN** repeatedly to choose the desired mode.

Each press changes the mode as follows:

SUBWOOFER*¹ → BASS*² → TREBLE*² → BALANCE →
FADER*³ → AUTO VOLUME*⁴ → DEFEAT → VOLUME →
SUBWOOFER*¹

Subwoofer: 0 ~ +15

Bass level: -7 ~ +7

Treble level: -7 ~ +7

Balance: L15 ~ R15

Fader: R15 ~ F15

Auto Volume: OFF/LOW/MIDDLE/HIGH

Defeat: ON/OFF

Volume: 0 ~ 35

- If no operation is performed for 5 seconds after selecting the SUBWOOFER, BASS, TREBLE, BALANCE, FADER, AUTO VOLUME or DEFEAT mode, the unit automatically returns to normal mode.

*¹ When the subwoofer mode is set to OFF, its level cannot be adjusted.

*² When the MultEQ (page 16) is set to OFF, its level cannot be adjusted.

*³ If you set the 4.2ch/2.2ch switch (pages 40 to 42) to 2.2ch, you cannot adjust this mode.

*⁴ By setting AUTO VOLUME, the unit can automatically adjust volume to a proper level according to engine/road noise, etc. There are three volume correction degrees: LOW, MIDDLE and HIGH.

- 2 Turn the **Rotary encoder** until the desired sound is obtained in each mode.

By setting DEFEAT ON, previously adjusted settings of BASS, TREBLE and EQ will return to the factory defaults, and MX (page 22) is turned off.

- Depending on the connected devices, some functions and display indications do not work.

Turning MultEQ on/off

MultEQ, developed by Audyssey Labs, automatically corrects the audio for the listening environment. The system is optimized for selected positions in the vehicle. To accomplish this, MultEQ must take measurements of the vehicles response characteristics. For details on the set up procedure, consult your authorized Alpine dealer.

Press **MultEQ** to select ON/OFF mode.

- If MultEQ is turned on and its button pressed and held for at least 2 seconds, the Curve mode is switched (only when curve1 and curve2 are stored).
- When using MultEQ, MX, X-OVER, T.CORRECTION, User's EQ, Parametric EQ and Graphic EQ are set automatically. They are no longer user adjustable.
- When an external audio processor is connected, the MultEQ function cannot be used.

Equalizer Presets

10 typical equalizer settings are preset at the factory for a variety of musical source material.

- 1 Press and hold **FUNC./SETUP** for at least 2 seconds to setup the Selection mode.
- 2 Turn the **Rotary encoder** to select AUDIO mode, and then press **►/II/ENT**.
- 3 Turn the **Rotary encoder** to select Factory's EQ mode, and then press **►/II/ENT**.
- 4 Turn the **Rotary encoder** to select the desired equalizer characteristic, and then press **►/II/ENT**.

Bluetooth ↔ GENERAL ↔ AUDIO ↔ DISPLAY ↔
TUNER ↔ Bluetooth

Flat ↔ Pops ↔ Rock ↔ News ↔ Jazz&Blues ↔
Electrical Dance ↔ Hip Hop&Rap ↔ Easy Listening ↔
Country ↔ Classical ↔ User1 ↔ User2 ↔ User3 ↔
User4 ↔ User5 ↔ User6

- By selecting User's 1 to 6, you can recall the stored preset number in "Adjusting and Storing the Graphic Equalizer Curve" (page 17) or "Adjusting and Storing the Parametric Equalizer Curve" (page 17).

- 5 Press and hold **FUNC./SETUP** for at least 2 seconds to return to normal mode.

- Pressing **AUDIO/RTN** during the procedure will return to the previous mode.
- If no operation is performed for 60 seconds in the SETUP mode, the setting mode is cancelled.
- This function is inoperable when DEFEAT is set to ON (page 16).
- Press and hold **Q/ESC** for at least 2 seconds, the setting mode is cancelled.

Setting EQ mode

This setting gives you a choice of 5-band parametric, or 7-band graphic equalizer.

- 1 Press and hold **FUNC./SETUP** for at least 2 seconds to setup the Selection mode.
- 2 Turn the **Rotary encoder** to select AUDIO mode, and then press **►/II/ENT**.
- 3 Turn the **Rotary encoder** to select EQ Mode, and then press **►/II/ENT**.

Bluetooth ↔ GENERAL ↔ AUDIO ↔ DISPLAY ↔ TUNER
↔ Bluetooth

4 Turn the Rotary encoder to select the desired equalizer characteristic, and then press ►/II/ENT.

Parametric EQ ↔ Graphic EQ
(Initial setting)

PEQ: 5-band Parametric EQ (Initial setting)
GEQ: 7-band Graphic EQ

5 Press and hold FUNC./SETUP for at least 2 seconds to return to normal mode.

- Pressing **AUDIO/RTN** during the procedure will return to the previous mode.
- If no operation is performed for 60 seconds in the **SETUP** mode, the setting mode is cancelled.
- This function is inoperable when **DEFEAT** is set to **ON** (page 16).
- Press and hold **Q/ESC** for at least 2 seconds, the setting mode is cancelled.

Adjusting and Storing the Parametric Equalizer Curve

You can modify the Equalizer settings to create a response curve more appealing to your personal taste.

To adjust the Parametric Equalizer Curve, set the EQ mode to Parametric EQ. For details, refer to “Setting EQ mode” (page 16).

1 Press A.SEL to recall the DSP adjust mode.

Media Xpander ↔ Crossover ↔ T.Correction ↔
Parametric EQ / Graphic EQ ↔ Media Xpander

2 Turn the Rotary encoder to select Parametric EQ mode, and then press ►/II/ENT.

3 Press BAND/TA to select the band to be adjusted.

Band1 → Band2 → Band3 → Band4 → Band5 → Band1

4 Press ◀ or ▶ to select frequency bands.

Adjustable frequency bands:
20 Hz to 20 kHz (in 1/3 octave steps)

Band-1: 20 Hz~80 Hz (63 Hz)
Band-2: 50 Hz~200 Hz (150 Hz)
Band-3: 125 Hz~3.2 kHz (400 Hz)
Band-4: 315 Hz~8 kHz (1 kHz)
Band-5: 800 Hz~20 kHz (2.5 kHz)

5 Turn the Rotary encoder to adjust the level.

Adjustable level: -6 to +6 dB

6 Press SOURCE/⏻ to set the bandwidth (Q).

Adjustable bandwidth: 1, 1.5, 3

7 To adjust another band, repeat steps 3 to 6 and adjust all bands.

8 When the setting has been completed, select any one of the preset buttons (1 through 6), press and hold the desired preset buttons for at least 2 seconds.

9 Turn the Rotary encoder to select PROTECT YES/NO, and then press ►/II/ENT to store the adjusted contents.

PROTECT YES ↔ PROTECT NO
(Initial setting)

- If **YES** is selected, the adjusted contents are protected and stored into the preset buttons. When you want to store the parameter into a protected preset button, “REPLACE NO/YES” can be selected.
- If **NO** is selected, the preset is stored.

10 After setting, press and hold Q/ESC for at least 2 seconds to return to normal mode.

- The frequencies of adjacent bands cannot be adjusted within 4 steps.
- This function is inoperable when **DEFEAT** is set to **ON** (page 16).
- While adjusting the Parametric EQ, you should consider the frequency response of the connected speakers.
- The stored contents are not deleted even when resetting the unit or disconnecting the battery.
- The stored contents can be recalled by performing operation in “Recalling the Stored Equalizer Curve” (page 18).
- Pressing **AUDIO/RTN** when Parametric EQ is adjusted will return to the previous item.
- If **MultiEQ** is turned on, the **A.SEL** button is ineffective. For details, refer to “Turning MultiEQ on/off” (page 16).
- If no operation is performed for 60 seconds, the unit will return to the normal mode.

Adjusting and Storing the Graphic Equalizer Curve

You can modify the equalizer settings to create a response curve more appealing to your personal taste. To adjust the graphic equalizer curve, set the EQ mode to Graphic EQ. For details, refer to “Setting EQ mode” (page 16).

1 Press A.SEL to recall the DSP adjust mode.

Media Xpander ↔ Crossover ↔ T.Correction ↔
Parametric EQ / Graphic EQ ↔ Media Xpander

2 Turn the Rotary encoder to select Graphic EQ mode, and then press ►/II/ENT.

3 Press BAND/TA to select the band to be adjusted.

Band1 → Band2 → Band3 → Band4 → Band5 →
Band6 → Band7 → Band1

Band-1 (63 Hz) / Band-2 (150 Hz) / Band-3 (400 Hz) /
Band-4 (1 kHz) / Band-5 (2.5 kHz) / Band-6 (6.3 kHz) /
Band-7 (17.5 kHz)

4 Turn the Rotary encoder to adjust the level.

Adjustable output level: -6 to +6 dB

5 To adjust another band, repeat steps 3 and 4, and then adjust all bands.

6 When the setting has been completed, select any one of the preset buttons (1 through 6), press and hold the desired preset buttons for at least 2 seconds to store the adjusted contents.

7 Turn the Rotary encoder to select PROTECT YES/NO, and then press ►/||/ENT to store the adjusted contents.

PROTECT YES ↔ PROTECT NO
(Initial setting)

- If YES is selected, the adjusted contents are protected and stored into the preset buttons. When you want to store the parameter into a protected preset button, "REPLACE NO/YES" can be selected.
- If NO is selected, the preset is stored.

8 After setting, press and hold Q/ESC for at least 2 seconds to return to normal mode.

- This function is inoperable when DEFEAT is set to ON (page 16).
- The stored contents can be recalled by performing operation in "Recalling the Stored Equalizer Curve" (page 18).
- Pressing AUDIO/RTN when Graphic EQ is adjusted will return to the previous item.
- If MultiEQ is turned on, the A.SEL button is ineffective. For details, refer to "Turning MultiEQ on/off" (page 16).
- If no operation is performed for 60 seconds, the unit will return to the normal mode.

Recalling the Stored Equalizer Curve

1 Press A.SEL to recall the DSP adjust mode.

Media Xpander ↔ Crossover ↔ T.Correction ↔
Parametric EQ / Graphic EQ ↔ Media Xpander

2 Turn the Rotary encoder to select the desired equalizer characteristic, and then press ►/||/ENT.

3 Press any one of the preset buttons (1 through 6) that has your desired equalizer characteristic in memory.

4 Press the preset buttons again to return to the DSP adjust mode.

5 Press and hold Q/ESC for at least 2 seconds to return to normal mode.

- This function is inoperable when DEFEAT is set to ON (page 16).
- You can recall the adjusted equalizer curve from "Equalizer Presets" (page 16).
- Pressing AUDIO/RTN during the procedure will return to the previous mode.
- If no operation is performed for 60 seconds, the unit will return to the normal mode.

About the Crossover

Crossover (X-OVER):

This unit is equipped with an active crossover. The crossover limits the frequencies delivered to the outputs. Each channel is controlled independently. Thus, each speaker pair can be driven by the frequencies for which they have been optimally designed.

The crossover adjusts the HPF (high pass filter) or LPF (low pass filter) of each band, and also the slope (how fast the filter rolls off the highs or lows). Adjustments should be made according to the reproduction characteristics of the speakers. Depending on the speakers, a passive network may not be necessary. If you are unsure about this point, please consult your authorized Alpine dealer.

4.2ch (F/R/Sub-W) mode

	Cut-off frequency (1/3 octave steps)		Slope		Level
	HPF	LPF	HPF	LPF	
Low range speaker	----	20 Hz - 200 Hz	----	FLAT, 6, 12, 18, 24 dB/oct.	0 to -12 dB
Rear high range speaker	20 Hz - 200 Hz	----	FLAT, 6, 12, 18, 24 dB/oct.	----	0 to -12 dB
Front high range speaker	20 Hz - 200 Hz	----	FLAT, 6, 12, 18, 24 dB/oct.	----	0 to -12 dB

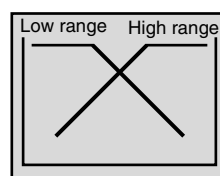

(Different from actual display)

2.2ch (3WAY) mode

	Cut-off frequency (1/3 octave steps)		Slope		Level
	HPF	LPF	HPF	LPF	
Low range speaker	----	20 Hz - 200 Hz	----	FLAT, 6, 12, 18, 24 dB/oct.	0 to -12 dB
Mid range speaker	20 Hz - 200 Hz	20 Hz - 20 kHz	FLAT, 6, 12, 18, 24 dB/oct.	FLAT, 6, 12, 18, 24 dB/oct.	0 to -12 dB
High range speaker	1 kHz - 20 kHz, (20 Hz - 20 kHz)*	----	FLAT* 6, 12, 18, 24 dB/oct.	----	0 to -12 dB

* Only when selecting User's in "Setting the Response Slope for the High Range Speaker (TW Setup)" (page 27).

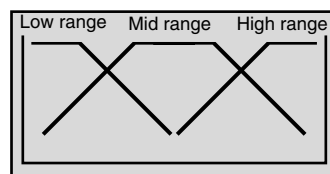

(Different from actual display)

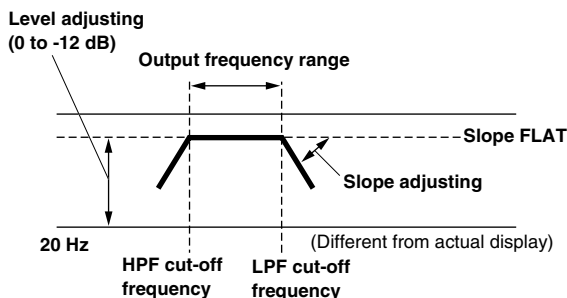

- **HPF (high pass filter):** Cuts the lower frequencies and allows the higher frequencies to pass.
- **LPF (low pass filter):** Cuts the higher frequencies and allows the lower frequencies to pass.
- **Slope:** The level change (in dB) for a frequency change of one octave.
- The higher the slope value, the steeper the slope becomes.
- Adjust the slope to **FLAT** to bypass the HP or LP filters.
- Do not use a tweeter without the HPF on or set to a low frequency, as it may cause damage to the speaker due to the low frequency content.
- You cannot adjust the crossover frequency higher than the HPF or lower than the LPF.
- Adjustment should be made according to the recommended crossover frequency of the connected speakers. Determine the recommended crossover frequency of the speakers. Adjusting to a frequency range outside that recommended may cause damage to the speakers. For the recommended crossover frequencies of Alpine speakers, refer to the respective Owner's Manual. We are not responsible for damage or malfunction of speakers caused by using the crossover outside the recommended value.

Adjusting and Storing the Crossover Settings

Before performing the following procedures, refer to "About the Crossover" (page 18).

- 1 Press **A.SEL** to recall the DSP adjust mode.
Media Xpander ↔ Crossover ↔ T.Correction ↔ Parametric EQ / Graphic EQ ↔ Media Xpander
- 2 Turn the **Rotary encoder** to select the Crossover mode, and then press **▶/II/ENT**.

2.2ch (3WAY) System

- 3 Press **BAND/TA** to select the band to be adjusted.

2.2ch (3WAY) System / L=R

Setting items:

LOW / MID-L / MID-H / HIGH

2.2ch (3WAY) System / L/R

Setting items:

LOW-L / LOW-R / MID-L-L / MID-L-R / MID-H-L / MID-H-R / HIGH-L / HIGH-R

- 4 Press **◀** or **▶** to select the desired cut-off frequency (Crossover Point).

2.2ch (3WAY) System

Setting items:

LOW / MID-L	20 Hz~200 Hz
MID-H	20 Hz~20 kHz
HIGH	(1 kHz~20 kHz)* ¹ /(20 Hz~20 kHz)* ²

- *¹ When **Maker's** is selected, refer to "Setting the Response Slope for the High Range Speaker (TW Setup)" (page 27).
*² When **User's** is selected, refer to "Setting the Response Slope for the High Range Speaker (TW Setup)" (page 27).

- 5 Press **SOURCE/Ⓞ** to adjust the slope.
Adjustable slope: FLAT*, 6 dB/oct., 12 dB/oct., 18 dB/oct., 24 dB/oct.

* **FLAT** can be set for the **HIGH** slope only when **User's** is selected in "Setting the Response Slope for the High Range Speaker (TW Setup)" (page 27). Depending on the response characteristics of the speaker, care should be taken when setting the response slope to **FLAT**, as speaker damage may result. With this unit, a message is displayed when the response slope for the high range speaker is set to **FLAT**.

- 6 Turn the **Rotary encoder** to adjust the output level.
Adjustable output level: -12 to 0 dB.

- 7 Repeat steps 3 to 6 to make adjustment to the other bands.

- 8 When the setting is complete, store into any one of the preset buttons (1 through 6) by pressing and holding the desired button for at least 2 seconds.

- 9 Turn the **Rotary encoder** to select **PROTECT YES/NO**, and then press **▶/II/ENT** to store the adjusted contents.

PROTECT YES ↔ PROTECT NO
(Initial setting)

- If **YES** is selected, the adjusted contents are protected and stored into the preset buttons. When you want to store the parameter into a protected preset button, "REPLACE NO/YES" can be selected.
- If **NO** is selected, the preset is stored.

- 10 After setting, press and hold **Q/ESC** for at least 2 seconds to return to normal mode.

- Pressing **AUDIO/RTN** during the procedure will return to the previous mode.
- If no operation is performed for 60 seconds, the unit will return to the normal mode.

4.2ch (F/R/Sub-W) System

- 3 Press **BAND/TA** to select the band to be adjusted.

4.2ch (F/R/Sub-W) System / L=R

Setting items:

LOW / MID / HIGH

4.2ch (F/R/Sub-W) System / L/R

Setting items:

LOW-L / LOW-R / MID-L / MID-R / HIGH-L / HIGH-R

- 4 Press **◀** or **▶** to select the desired cut-off frequency (Crossover Point).

Adjustable frequency bands:

4.2ch (F/R/Sub-W) System

Setting items:

20 Hz~200 Hz

- 5 Press **SOURCE/Ⓞ** to adjust the slope.
Adjustable slope: FLAT, 6 dB/oct., 12 dB/oct., 18 dB/oct., 24 dB/oct.

6 Turn the Rotary encoder to adjust the output level.

Adjustable output level: -12 to 0 dB.

7 Repeat steps 3 to 6 to make adjustment to the other bands.

- While adjusting the X-over, you should consider the frequency response of the connected speakers.
- The stored contents are not deleted even when resetting the unit or disconnecting the battery.
- The stored contents can be recalled by performing operation in "Recalling the Stored Crossover Settings" (page 20).
- Pressing **AUDIO/RTN** when X-over is adjusted will return to the previous item.
- If **MultEQ** is turned on, the **A.SEL** button is ineffective. For details, refer to "Turning MultEQ on/off" (page 16).
- About the 4.2ch (F/R/Sub-W) / 2.2ch (3WAY) system
You can switch to 4.2ch (F/R/Sub-W) / 2.2ch (3WAY) system mode with the 4.2ch (F/R/Sub-W) / 2.2ch (3WAY) switch on the bottom side of the unit (pages 40 to 42).

When setting to "3WAY":

The unit can be operated in a 2.2ch system.

When setting to "F/R/Sub-W":

The unit can be operated in a 4.2ch system.



Recalling the Stored Crossover Settings

1 Press **A.SEL** to recall the DSP adjust mode.

Media Xpander ↔ Crossover ↔ T.Correction ↔
Parametric EQ / Graphic EQ ↔ Media Xpander

2 Turn the Rotary encoder to select the Crossover mode, and then press **▶/II/ENT**.

3 Press any one of the preset buttons (1 through 6) that has your desired characteristic in memory.

4 Press the preset buttons again to return to the DSP adjust mode.

5 Press and hold **Q/ESC** for at least 2 seconds to return to normal mode.

- Pressing **AUDIO/RTN** during the procedure will return to the previous mode.

About Time Correction

The distance between the listener and the speakers in a car vary widely due to the complex speaker placement. This difference in the distances from the speakers to the listener creates a shift in the sounds image and frequency characteristics. This is caused by the time delay between the sound reaching the listener's right versus the left ear.

To correct this, this unit is able to delay the audio signal to the speakers closest to the listener. This effectively creates a perception of increased distance for those speakers. The listener can be placed at an equal distance between the left and right speakers for optimum staging. The adjustment will be made for each speaker in 3.4 cm steps.

Example 1. Listening Position: Front Left Seat

Adjust the time correction level of the front left speaker to a high value and the rear right to zero or a low value.

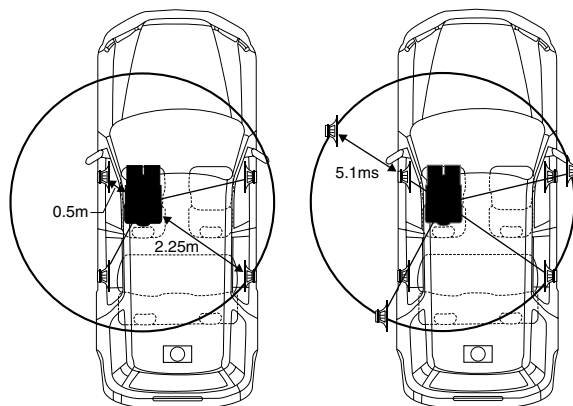

The sound is not balanced because the distance between the listening position and the various speakers is different. The difference in distance between the front left speaker and the rear right speaker is 1.75 m (68-7/8"). Here we calculate the time correction value for the front left speaker in the diagram on the above.

Conditions:

Farthest Speaker – listening position : 2.25 m (88-9/16")

Front left speaker – listening position : 0.5 m (19-11/16")

Calculation: $L = 2.25 \text{ m} - 0.5 \text{ m} = 1.75 \text{ m (68-7/8")}$

Time correction = $1.75 \div 343^{*1} \times 1,000 = 5.1 \text{ (ms)}$

^{*1} Speed of sound: 343 m/s (765 mph) at 20°C

In other words, giving the front left speaker a time correction value of 5.1 ms makes it seem as if its distance from the listener is the same as the distance to the farthest speaker.

Time correction eliminates the differences in the time required for the sound to reach the listening position.

The time of the front left speaker is corrected by 5.1 ms so that its sound reaches the listening position at the same time as the sound of other speakers.

Example 2. Listening Position: All Seats

Adjust the time correction level of each speaker to almost the same level.

1 Sit in the listening position (driver's seat, etc.) and measure the distance (in meters) between your head and the various speakers.

2 Calculate the difference between the distance to the farthest speaker and the other speakers.

$L = (\text{distance to farthest speaker}) - (\text{distance to other speakers})$

3 Divide the distances calculated for the speakers by the speed of sound (343 m/s (765 mph) at 20°C).

These values are the time correction values for the different speakers.

Time Difference Table

Delay Number	Distance (cm)	Distance (inch)	Delay Number	Distance (cm)	Distance (inch)
0	0.0	0.0	51	173.4	68.3
1	3.4	1.3	52	176.8	69.7
2	6.8	2.7	53	180.2	71.0
3	10.2	4.0	54	183.6	72.4
4	13.6	5.4	55	187.0	73.7
5	17.0	6.7	56	190.4	75.0
6	20.4	8.0	57	193.8	76.4
7	23.8	9.4	58	197.2	77.7
8	27.2	10.7	59	200.6	79.1
9	30.6	12.1	60	204.0	80.4
10	34.0	13.4	61	207.4	81.7
11	37.4	14.7	62	210.8	83.1
12	40.8	16.1	63	214.2	84.4
13	44.2	17.4	64	217.6	85.8
14	47.6	18.8	65	221.0	87.1
15	51.0	20.1	66	224.4	88.4
16	54.4	21.4	67	227.8	89.8
17	57.8	22.8	68	231.2	91.1
18	61.2	24.1	69	234.6	92.5
19	64.6	25.5	70	238.0	93.8
20	68.0	26.8	71	241.4	95.1
21	71.4	28.1	72	244.8	96.5
22	74.8	29.5	73	248.2	97.8
23	78.2	30.8	74	251.6	99.2
24	81.6	32.2	75	255.0	100.5
25	85.0	33.5	76	258.4	101.8
26	88.4	34.8	77	261.8	103.2
27	91.8	36.2	78	265.2	104.5
28	95.2	37.5	79	268.6	105.9
29	98.6	38.9	80	272.0	107.2
30	102.0	40.2	81	275.4	108.5
31	105.4	41.5	82	278.8	109.9
32	108.8	42.9	83	282.2	111.2
33	112.2	44.2	84	285.6	112.6
34	115.6	45.6	85	289.0	113.9
35	119.0	46.9	86	292.4	115.2
36	122.4	48.2	87	295.8	116.6
37	125.8	49.6	88	299.2	117.9
38	129.2	50.9	89	302.6	119.3
39	132.6	52.3	90	306.0	120.6
40	136.0	53.6	91	309.4	121.9
41	139.4	54.9	92	312.8	123.3
42	142.8	56.3	93	316.2	124.6
43	146.2	57.6	94	319.6	126.0
44	149.6	59.0	95	323.0	127.3
45	153.0	60.3	96	326.4	128.6
46	156.4	61.6	97	329.8	130.0
47	159.8	63.0	98	333.2	131.3
48	163.2	64.3	99	336.6	132.7
49	166.6	65.7			
50	170.0	67.0			

Setting the Time Correction Unit

You can change the unit, (cm or inch) of time correction.

- 1 Press and hold **FUNC./SETUP** for at least 2 seconds to setup the Selection mode.
- 2 Turn the **Rotary encoder** to select **AUDIO mode**, and then press **▶/||/ENT**.

Bluetooth ↔ GENERAL ↔ AUDIO ↔ DISPLAY ↔ TUNER ↔ Bluetooth

- 3 Turn the **Rotary encoder** to select **T.CORR Parameter mode**, and then press **▶/||/ENT**.
- 4 Turn the **Rotary encoder** to select the desired items, and then press **▶/||/ENT**.
T.CORR Parameter<cm> ↔ T.CORR Parameter<inch> (Initial setting)
- 5 After setting, press and hold **FUNC./SETUP** for at least 2 seconds to return to normal mode.

- Pressing **AUDIO/RTN** during the procedure will return to the previous mode.
- If no operation is performed for 60 seconds in the **SETUP** mode, the setting mode is cancelled.
- Press and hold **Q/ESC** for at least 2 seconds, the setting mode is cancelled.

Adjusting and Storing the Time Correction

Before performing the following procedures, refer to “About Time Correction” (page 20).

- 1 Press **A.SEL** to recall the **DSP adjust mode**.
Media Xpander ↔ Crossover ↔ T.Correction ↔ Parametric EQ / Graphic EQ ↔ Media Xpander
- 2 Turn the **Rotary encoder** to select the **T.Correction mode**, and then press **▶/||/ENT**.
- 3 Press **BAND/TA** to select a speaker to be adjusted.

2.2ch (3WAY) System

L-F (Initial setting) → R-F → L-R → (Mid-L) (Mid-R) (High-L)
R-R → L-SW → R-SW → L-F (High-R) (Mid-L)

4.2ch (F/R/Sub-W) System

L-F (Initial setting) → R-F → L-R → (Front-L) (Front-R) (Rear-L)
R-R → L-SW → R-SW → L-F (Rear-R) (Front-L)

- 4 Turn the **Rotary encoder** to adjust distance (0.0 to 336.6 cm).

- 5 Repeat steps 3 and 4 to set another speaker.
- 6 When the setting has been completed, select any one of the **preset buttons (1 through 6)**, press and hold the desired preset buttons for at least 2 seconds.

- 7 Turn the **Rotary encoder** to select **PROTECT YES/NO**, and then press **►/II/ENT** to store the adjusted contents.

PROTECT YES ↔ PROTECT NO
(Initial setting)

- If YES is selected, the adjusted contents are protected and stored into the preset buttons. When you want to store the parameter into a protected preset button, "REPLACE NO/YES" can be selected.
- If NO is selected, the preset is stored.

- 8 After setting, press and hold **Q/ESC** for at least 2 seconds to return to normal mode.

- The stored contents are not deleted even when resetting the unit or disconnecting the battery.
- The stored contents can be recalled by performing operation in "Recalling the Stored Time Correction Settings" (page 22).
- Pressing **AUDIO/RTN** when Time Correction is adjusted will return to the previous item.
- If **MultiEQ** is turned on, the **A.SEL** button is ineffective. For details, refer to "Turning MultiEQ on/off" (page 16).
- If no operation is performed for 60 seconds, the unit will return to the normal mode.

Recalling the Stored Time Correction Settings

- 1 Press **A.SEL** to recall the DSP adjust mode.

Media Xpander ↔ Crossover ↔ T.Correction ↔
Parametric EQ / Graphic EQ ↔ Media Xpander

- 2 Turn the **Rotary encoder** to select the **T.Correction mode**, and then press **►/II/ENT**.

- 3 Press any one of the **preset buttons (1 through 6)** that has your desired characteristic in memory.

- 4 Press the preset buttons again to return to the DSP adjust mode.

- 5 Press and hold **Q/ESC** for at least 2 seconds to return to normal mode.

- Pressing **AUDIO/RTN** during the procedure will return to the previous mode.

Setting the MX Mode

MX (Media Xpander) makes vocals or instruments sound distinct regardless of the music source. The FM radio, CD, and iPod, will be able to reproduce the music clearly even in cars with a lot of road noise.

- 1 Press **SOURCE/⏻** to select the source to which you want to apply Media Xpander.

- 2 Press **A.SEL** to recall the DSP adjust mode.

Media Xpander ↔ Crossover ↔ T.Correction ↔
Parametric EQ / Graphic EQ ↔ Media Xpander

- 3 Turn the **Rotary encoder** to select the **Media Xpander mode**, and then press **►/II/ENT**.

- 4 Turn the **Rotary encoder** to select the desired **Media Xpander level**.

FM (MX level 1 to 3):

The medium to high frequencies become clearer, and produces well balanced sound at all frequencies.

CD (MX level 1 to 3):

CD mode processes a large amount of data during playback. MX takes advantage of this large data quantity to reproduce a more clear, clean output.

CMPM (MX level 1 to 3):

This corrects information that was lost at the time of compression. This reproduces a well-balanced sound close to the original.

DVD (Video CD)

(MOVIE MX level 1 to 2):

The dialogue portion of a video is reproduced more clearly.

(DVD MUSIC):

A DVD or Video CD contains a large quantity of data such as music clip. MX uses this data to reproduce the sound accurately.

AUX (MX level 1):

Choose the MX mode (CMPM, MOVIE, or MUSIC) that corresponds to the media connected. If two external devices are connected, a different MX mode for each media can be selected.

- 5 After setting, press and hold **Q/ESC** for at least 2 seconds to return to normal mode.

- To cancel MX mode for all music sources, set MX to OFF.
- Each music source, such as FM radio, CD, and MP3/WMA/AAC can have its own MX setting.
- On disks with both MP3/WMA/AAC and CD-DA, when the source changes from "MP3/WMA/AAC to CD-DA" or "CD-DA to MP3/WMA/AAC", MX-mode switching may delay playback slightly.
- Setting to Non Effect sets MX mode of each music source to OFF.
- This function is inoperable when DEFEAT is set to ON.
- There is no MX mode for MW and LW radio.
- If an audio processor with the MX function (PXA-H701, etc.) is connected, its own MX processing is applied to the music source. Since the processor MX settings may not match the head unit, the audio processor needs to be adjusted. For details, refer to the Owner's Manual of the audio processor.
- "CMPM" is applied for MP3/WMA/AAC and iPod.
- If no operation is performed in 60 seconds, the unit will return to the normal mode.

Other Functions

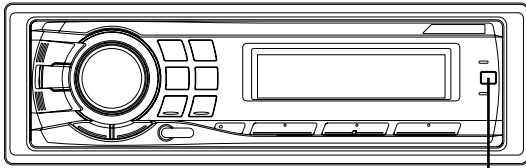

TITLE

Displaying the Text

Text information, such as the disc name and the track name, will be displayed if playing a CD text compatible disc. It is also possible to display the folder name, the file name and the tag, etc., while playing MP3/WMA/AAC files.

Press **TITLE**.

The display will change every time the button is pressed.

- If you want to change the display when the Text Scroll is set to Manual, press **TITLE** while the text is scrolling. If the scroll has been completed, press **TITLE** to scroll the text again.

The display in Radio mode:

If there is PS (Programme Service Name)

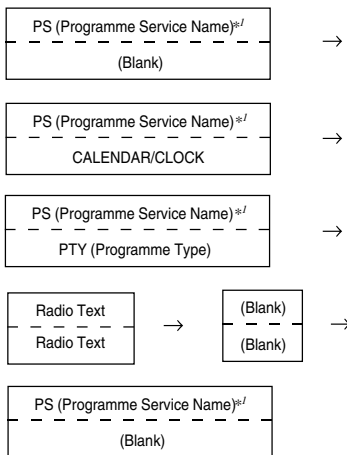

If there is no PS (Programme Service Name)

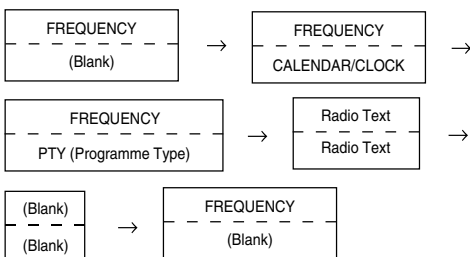

The display in CD mode:

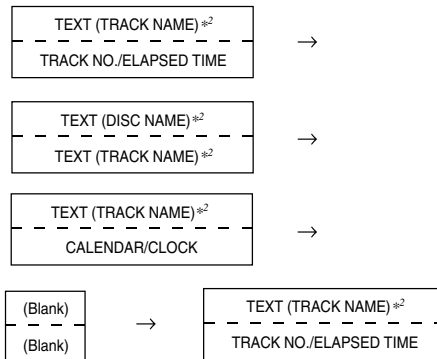

The display in MP3/WMA/AAC mode:

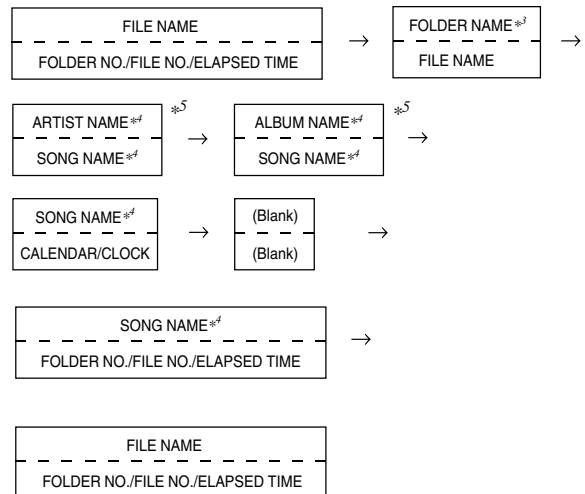

*1 Press and hold **TITLE** for at least 2 seconds if PS is displayed in the radio mode, frequency will be displayed for 5 seconds.

*2 Displayed during playback of a disc with CD Text.

*3 The root folder is displayed as blank.

*4 ID3 tag/WMA tag

If an MP3/WMA/AAC file contains ID3 tag/WMA tag information, the ID3 tag/WMA tag information is displayed (e.g., song name, artist name, and album name). All other tag data is ignored.

*2-4 If there is no text information, nothing will be displayed.

*5 If "Text Scroll Auto" is set in "Scroll Setting (Text Scroll)" (page 28), the display cannot be switched by pressing **TITLE**. The display contents switch alternately.

About the indication display

When displaying Text, the following indicators are lit according to the mode.

Indicator/Mode	CD Mode	MP3/WMA/AAC Mode	iPod Mode
	—	Folder Name being displayed	—
	—	Song Name being displayed	Song Name being displayed
	—	Artist Name being displayed	Artist Name being displayed
	—	Album Name being displayed	Album Name being displayed
	—	File Name being displayed	—
	Text (Disc Name) being displayed	—	—
	Text (Track Name) being displayed	—	—

About “Text”

Text:

Text compatible CDs contain text information such as the disc name and track name. Such text information is referred to as “text.”

- Some characters may not be displayed correctly with this device, depending on the character type.
- The CD changer must also be CD Text compatible for the Text information to be displayed.
- If there is no TEXT information, the display is blank.
- The text or tag information may not be correctly displayed, depending on the contents.

Displaying Time

Press **TITLE** repeatedly until the time is displayed.

Each press changes the display.

For details, see “Displaying the Text” (page 23).

- Selecting any tuner or CD function while in the clock priority mode will interrupt the time display momentarily. The function selected will be displayed for about 5 seconds before the time returns to the display.

Blackout Mode On and Off

When Blackout mode is turned on (except Radio Mode), all display indications on this unit will turn off to reduce power consumption. This additional power enhances the sound quality.

Press and hold **TITLE** for at least 2 seconds to activate the blackout mode.

All display indications on this unit will turn off.

The “B.OUT” indicator lights up.

- If any button on the unit is pressed during the blackout mode, the function will be displayed for 5 seconds to show the operation before returning to Blackout mode.

To cancel Blackout mode, press and hold **TITLE** for at least 2 seconds.

SETUP

You can flexibly customize the unit to suit your own preferences and usage. From the **SETUP** menu, Audio Setting, Display Setting, etc., can be modified.

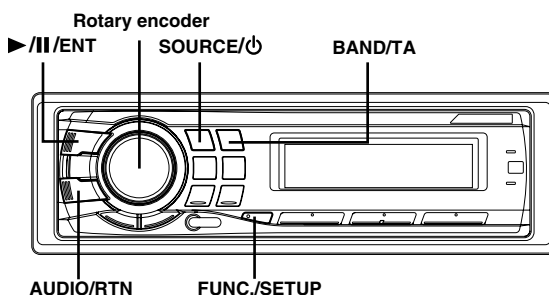

Use steps 1 to 5 to select one of the **SETUP** modes to modify. See the applicable section below for details about the selected **SETUP** item.

- 1 Press and hold **FUNC./SETUP** for at least 2 seconds to activate the **SETUP** selection mode.
- 2 Turn the **Rotary encoder** to select the desired item, and then press **>/II/ENT**.
Bluetooth*¹ ↔ GENERAL ↔ AUDIO ↔ DISPLAY ↔ TUNER ↔ Bluetooth*¹
(e.g. Select AUDIO)
- 3 Turn the **Rotary encoder** to select a setting item, and then press **>/II/ENT**.
(e.g. Select Subwoofer)

Bluetooth*¹:
Bluetooth IN

GENERAL:
Birthday Set ↔ Clock Mode ↔ Clock ↔ Clock Adjust*² ↔ Play Mode ↔ Beep ↔ INT Mute*³ ↔ AUX+ Setup ↔ AUX IN ↔ AUX Name*⁴ ↔ Digital AUX ↔ Power IC ↔ Steering ↔ Language Set ↔ Demo ↔ Birthday Set

AUDIO:
Subwoofer ↔ SUBW. System*⁵ ↔ ‘Factory’ s EQ*⁶ ↔ T.CORR Parameter*⁷ ↔ Filter Type ↔ SUBW. Phase ↔ SUBW. Channel ↔ TW Setup*⁸ ↔ EQ Mode*⁹ ↔ Subwoofer

DISPLAY:
Illumination ↔ Dimmer ↔ Scroll Type ↔ Text Scroll ↔ Font Select ↔ BGV Select ↔ Calendar ↔ Opening MSG ↔ Illumination

TUNER:
FM Level ↔ RDS Regional*¹⁰ ↔ Alert PTY31*¹¹ ↔ PI Seek*¹² ↔ Auto Clock*¹³ ↔ FM Level

*¹ Displayed only when INT Mute is OFF.

*² Refer to “Setting the Time and Calendar” (page 7).

*³ Displayed only when Bluetooth IN is OFF.

*⁴ Displayed only when AUX IN is ON.

*⁵ Displayed only when Subwoofer is ON.

*⁶ Refer to “Equalizer Presets” (page 16).

*⁷ Refer to “Setting the Time Correction Unit” (page 21).

*⁸ Displayed only when 2.2ch (3WAY) is set.

*⁹ Refer to “Setting EQ mode” (page 16).

*¹⁰ Refer to “Receiving RDS Regional (Local) Stations” (page 9).

*¹¹ Refer to “Setting PTY31 (Emergency Broadcast) reception” (page 10).

*¹² Refer to “PI SEEK Setting” (page 10).

*¹³ Refer to “Setting the Time to automatically Adjust” (page 10).

*¹⁴ These items cannot be adjusted when MultiEQ (page 16) is set to ON.

4 Turn the **Rotary encoder** to change the setting, and then press **►/||/ENT**.

(e.g. Select Subwoofer ON or Subwoofer OFF.)

5 Press and hold **FUNC./SETUP** for at least 2 seconds to return to normal mode.

- Pressing **AUDIO/RTN** returns to the previous **SETUP** mode.
- If no operation is performed for 60 seconds, **SETUP** is cancelled.

Bluetooth Setting

Select Bluetooth from the setup main menu in step 2 above.

If an optional Bluetooth Box is connected, you can place a hands-free call by a Bluetooth- equipped mobile phone.

Make this setting when the Bluetooth Box is connected and the Bluetooth function is used. For details, refer to the Owner's Manual of the optional Bluetooth Box.

Setting the Bluetooth IN Connection

Bluetooth IN ADAPTER / Bluetooth IN OFF (Initial Setting)

Set ADAPTER when the Bluetooth Box is connected.

General Setting

GENERAL is selected on the setup main menu in step 2.

BirthDay Opening Message Setting (BirthDay Set)

mm/dd

While Opening MSG is set to ON (refer to "Opening Message ON/OFF Setting" on page 28), and then input your birthday details, a message can be displayed on that day.

Turn the **Rotary encoder** to set "mm" (Month), then press **►/||/ENT**.

Turn the **Rotary encoder** again to set "dd" (Date).

Setting the Clock Display (Clock Mode)

AM (Before noon) 12:00 (12HOUR) / 00:00 (24HOUR) (Initial setting)

You can select the clock display type, 12-hour or 24-hour, depending on your preference.

Turning the Clock Display ON/OFF (Clock)

Clock ON (Initial Setting) / Clock OFF

When ON is set, the time always appears in the lower left of the display.

Playing MP3/WMA/AAC Data (Play Mode)

CD-DA (Initial setting) / CDDA&MP3/WMA

This unit can play back CDs containing both CD and MP3/WMA/AAC data (created in Enhanced CD (CD Extra) format). However, in some situations, playback of an enhanced CD may be difficult. In this case, you can select playback of a single session only, containing the CD data.

When a disc contains both CD and the MP3/WMA/AAC data, playback starts from the CD data portion of the disc.

CD-DA : Only the CD data in Session 1 can be played back.

CDDA&MP3/WMA: CD data, MP3/WMA/AAC files in mixed mode, and multi-session discs can be played back.

- Perform this setting before inserting a disc. If a disc has already been inserted, remove it first. (If you use an MP3 changer, you have to change discs.)

Sound (Beep) Guide Function

Beep ON (Initial setting) / Beep OFF

This function will give audible feedback with varying tones depending upon the button pressed.

Turning Mute Mode On/Off (INT Mute)

INT Mute ON / INT Mute OFF (Initial setting)

If a device having the interrupt feature is connected, audio will be automatically muted whenever the interrupt signal is received from the device.

Setting the AUX+ Setup Mode

AUX+ Setup ON / AUX+ Setup OFF (Initial Setting)

You can input the audio of a connected external device, (such as a portable player) to the iPod Direct connector of this unit, using an iPod Direct/RCA Interface cable.

An external device and an iPod cannot be connected at the same time.

AUX+ ON : Set to ON when an external device is connected. If **SOURCE/⏻** is pressed and AUX+ is selected, the sound of the external device is input to the unit.

AUX+ OFF : Set to OFF when an iPod is connected.

Setting the AUX Mode (V-Link)

AUX IN ON / AUX IN OFF (Initial setting)

You can input TV/video sound by connecting an optional Ai-NET/RCA Interface cable (KCA-121B) or Versatile Link Terminal (KCA-410C) to this component.

You can change the AUX name display when AUX IN is set to ON.

Press **►/||/ENT** when AUX IN is set to ON, and select AUX Name by turning the **Rotary encoder**, then press **►/||/ENT**.

After that, turn the **Rotary encoder** to select the desired AUX name.

If the KCA-410C is connected, it is possible to select two AUX names.

- Via KCA-410C, up to 2 external devices with RCA output can be connected. In this case, press **SOURCE/⏻** to select AUX mode and then press **BAND/TA** to select your desired device.

Setting the External Digital Input (Digital AUX)

Digital AUX ON / Digital AUX OFF (Initial setting)

When an ALPINE Ai-NET compatible digital audio processor (PXA-H701) and a DVD player (DVE-5207) not compatible with Ai-NET are connected, set Digital AUX to ON to enjoy 5.1-channel surround sound.

- Press **SOURCE/⏻**, and select the D.AUX mode, and adjust the volume, etc.
- After input selection is completed, turn the ignition off and back on again. Setting of the optical digital input switch is completed.
- Depending on the connected audio processor, DVD player sound may continue to be output, even though the source is changed to another one. If this occurs, set the DVD player's power to OFF.

Connecting to an External Amplifier

Power IC ON (Initial setting) / Power IC OFF

When an external amplifier is connected, sound quality can be improved by stopping the power supply of the built-in amplifier.

Power IC OFF: Use this mode when the line output of this unit is used to drive an external amplifier. In this setting, the head unit's internal amplifier is turned OFF and can not drive speakers.

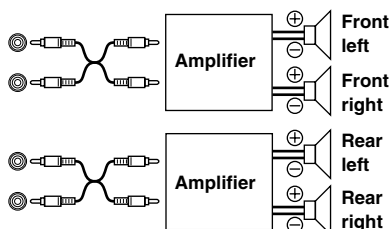

Power IC ON: The speakers are driven by the built-in amplifier.

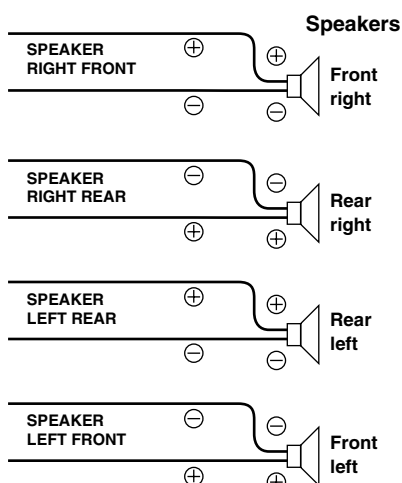

- No sound is produced by the system when the power output is set to OFF.

Setting Adaptive Steering Remote Control

Steering ON / Steering OFF (Initial Setting)

This unit is compatible with the adaptive steering remote control.

This function allows operation by sending the steering remote control signal to the unit.

To use the steering remote control, perform the following button operations after setting to ON and pressing ►/||/ENT.

For details, consult your nearest Alpine dealer.

- Select the assigned function by turning the Rotary encoder.**

(e.g. Select SOURCE)

POWER ↔ SOURCE ↔ BAND ↔ VOL. UP ↔ VOL. DN ↔
PAUSE ↔ MUTE ↔ BWD ↔ FWD ↔ P. UP ↔ P. DN ↔
A.PROC ↔ POWER

FF SOURCE FF

- Press the steering remote control button until the changed signal value of steering remote control appears in the left of the display.**

(e.g. Press SOURCE of the steering remote control button.)

The changed steering remote control signal appears in the left of the display.

DE SOURCE FF

The changed signal value of steering remote control

- Press ►/||/ENT to execute the setting value.**

The confirmed signal value of steering remote control appears in the right of the display. With doing so, the function of the unit is assigned to the steering remote control button.

DE SOURCE DE

The confirmed signal value of steering remote control

- Repeat steps 1 to 3, and set each button.**

When settings have been completed, press AUDIO/RTN to return to the previous mode.

Setting the Language Font (Language Set)

Language 1 (Initial Setting) / Language 2 / Language 3

Three types of font can be selected.

Language 1 : Normal font
Language 2 : European font
Language 3 : Russian font

Demonstration

Demo ON / Demo OFF (Initial setting)

This unit has a demonstration feature for the display and sound.

- To quit Demo mode, set to Demo OFF.

Audio Setting

AUDIO is selected on the setup main menu in step 2.

Subwoofer On and Off

Subwoofer ON (Initial setting) / Subwoofer OFF

When the subwoofer is on, perform the steps below to adjust the subwoofer output level.

- 1 In the normal mode, press **AUDIO/RTN** repeatedly to select the **SUBWOOFER** mode.
SUBWOOFER → **BASS** → **TREBLE** → **BALANCE** → **FADER**
→ **AUTO VOLUME** → **DEFEAT** → **VOLUME** → **SUBWOOFER**
- 2 Adjust the level by turning the **Rotary encoder**.

Setting the Subwoofer System

System1 (Initial setting) / System2

Select either System1 or System2 for the desired subwoofer effect.

- System1:** Subwoofer level changes according to the main volume setting.
- System2:** Subwoofer level change is different from the main volume setting. For example, even at low volume settings, the subwoofer is still audible.

Setting the Filter Type

L=R (Initial setting) / L/R

- L=R:** Left and right speakers are adjusted equally.
- L/R:** Left and right speakers are individually adjusted.

Setting the Subwoofer phase

SUBW. Phase 0° (Initial setting) / SUBW. Phase 180°

The subwoofer output phase is toggled **SUBWOOFER NORMAL** (0°) or **SUBWOOFER REVERSE** (180°). To adjust the level, turn the **Rotary encoder**.

Setting the Subwoofer Output (SUBW. Channel)

SUBW. Channel Stereo (Initial setting) / Mono

You can set the subwoofer output to stereo or monaural. Make sure to set the correct output for your subwoofer type.

- Stereo:** Subwoofer stereo (L/R) output
- Mono:** Subwoofer monaural output

Setting the Response Slope for the High Range Speaker (TW Setup)

TW Setup Maker's (Initial setting) / TW Setup User's

Depending on the response characteristics of the speaker, care should be taken when setting the response slope of the high range speaker to **FLAT** in 2.2ch (3WAY) mode (see "Adjusting and Storing the Crossover Settings" on page 19), as speaker damage may result.

Maker's: As protection from possible speaker damage, **FLAT** cannot be set for the response slope of the high range speaker in 2.2ch (3WAY) mode.

User's: The **FLAT** setting is possible in 2.2ch (3WAY) mode.

Display Setting

DISPLAY is selected on the setup main menu in step 2.

Changing Lighting Colour (Illumination)

Illumination TYPE 1 (Initial setting) / TYPE 2 / TYPE 3 / TYPE 4 / TYPE 5

TYPE 1 ↔ TYPE 2 ↔ TYPE 3 ↔ TYPE 4 ↔ TYPE 5

You can change the lighting colour of the following seven buttons. **SOURCE/⏻**, **BAND/TA**, **◀**, **▶**, **◀◀**, **▶▶** and **MultEQ**.

- TYPE 1:** When the colour of the seven buttons is blue, the colour of the other is green.
- TYPE 2:** When the colour of the seven buttons is green, the colour of the other is green.
- TYPE 3:** When the colour of the seven buttons is blue, the colour of the other is red.
- TYPE 4:** When the colour of the seven buttons is amber, the colour of the other is red.
- TYPE 5:** When the colour of the seven buttons is red, the colour of the other is red.

Dimmer Control

Dimmer Auto (Initial setting) / Dimmer Manual

Set the Dimmer control to Auto to decrease the illumination brightness of the unit with the head lights of the vehicle ON. This mode is useful if you feel the unit's backlighting is too bright at night.

- If your vehicle should have a dimmer control for the dashboard lights, never connect the **DIMMER** cable (orange) of the radio to this dimmer control.

Scroll Type Setting

Scroll Type TYPE 1 / Scroll Type TYPE 2 (Initial setting)

Choose from two scrolling methods.

Select the type you prefer.

- TYPE 1: The characters scroll from right to left, a single character at a time, until the entire title has scrolled.
- TYPE 2: Words are built up from left to right, a single character at a time. When the display is filled, it is cleared and the remaining words are displayed the same way until all words of the title have been shown.

Scroll Setting (Text Scroll)

Text Scroll Auto / Text Scroll Manual (Initial setting)

This CD player can scroll the disc and track names recorded on CD-TEXT discs, as well as the text information of MP3/WMA/AAC files, folder names and tags.

- Auto: CD text information, folder and file names, and the tag information are scrolled continuously.
- Manual: The above information is scrolled only when a disc is loaded, a channel or track is changed, etc.

- *In parts of the display, scrolling may not occur, or scroll content may differ.*

Switching the Character Font (Font Select)

TYPE 1 (Initial setting) / TYPE 2

Two types of font can be selected.

You can select the font type you like.

Switching the Animation Display Type (BGV Select)

OFF (Initial setting) / TYPE 1 / TYPE 2 / TYPE 3 / TYPE 4

You can select from 4 types of animation display for the display background.

Setting of Calendar Display Pattern Switching (Calendar)

dd/mm/yyyy (Initial setting) / yyyy/mm/dd / mm/dd/yyyy

You can switch the calendar display pattern to be shown when the time is displayed.

- yyyy: shows the year
mm: shows the month
dd: shows the day

ex. dd/mm/yyyy → 25/12/2006

Opening Message ON/OFF Setting

Opening MSG ON / Opening MSG OFF (Initial setting)

This unit includes a special message feature with various patterns, which when enabled displays opening messages for certain occasions. For example, when you turn this unit on December 25th (according to the unit's date setting), a Christmas greeting is displayed if the Opening Message is set to ON.

Tuner Setting

TUNER is selected on the setup main menu in step 2.

Adjusting Source Signal Levels (FM Level)

FM Level High (Initial setting) / FM Level Low

If the difference in volume level between the CD player and FM radio is too great, adjust the FM signal level.

iPod® (Optional)

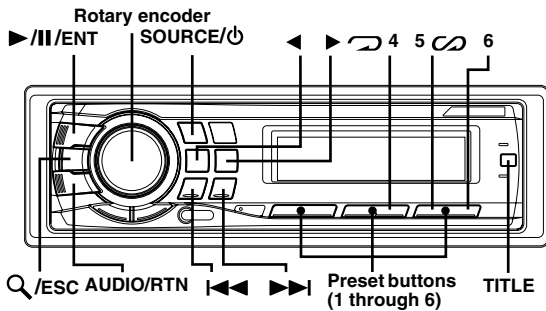

An iPod® can be connected to this unit by using the proprietary ALPINE FULL SPEED™ Connection Cable (KCE-422i) (sold separately). When this unit is connected by using the cable, the controls on the iPod are not functional.

- Set AUX+ Setup to OFF when an iPod is connected (refer to “Setting the AUX+ Setup Mode” on page 25).

iPods usable with this unit

- The unit can be used with the fourth generation and above iPod, iPod photo, iPod mini or iPod nano. iPod Shuffle cannot be used, however.
- Touch wheel or scroll wheel type iPods without the dock connector cannot be connected to the unit.
- The unit can be used with the following iPod versions. Correct function of earlier versions cannot be guaranteed.

Fourth generation iPod: Ver. 3.1.1
 Fifth generation iPod: Ver. 1.1.2
 iPod photo: Ver. 1.2.1
 iPod mini: Ver. 1.4.1
 iPod nano: Ver. 1.2

- The unit cannot be used with software versions earlier than “2006-06-28”. For details about “iPod Software Update”, refer to the iPod Instruction Manual.

Playback

1 Press SOURCE/⏻ to switch to the iPod mode.

TUNER → DISC → iPod*¹ → CHANGER*² → TUNER

*¹ Only when the iPod is connected.

*² Only when the CD changer is connected.

2 Press ◀◀ or ▶▶ to select the desired song.

Return to the beginning of the current song:

Press ◀◀.

Fast backward:

Press and hold ◀◀.

Advance to the beginning of the next song:

Press ▶▶.

Fast forward:

Press and hold ▶▶.

3 To pause playback, press ▶/||/ENT.

Pressing ▶/||/ENT again will resume playback.

- A song playing on the iPod while it is connected to this unit will continue to play from where it was paused after disconnection.

Searching for a desired Song

An iPod can contain hundreds of songs. By using file tag information and keeping these songs organized in playlists, this unit's search functions will ease song searches.

Each music category has its own individual hierarchy. Use the Playlist/Artist/Album/Song/Podcast/Genre/Composer search mode to narrow searches based on the table below.

Hierarchy 1	Hierarchy 2	Hierarchy 3	Hierarchy 4
Playlist	Song	—	—
Artist*	Album*	Song	—
Album*	Song	—	—
Song	—	—	—
Podcast	Episode	—	—
Genre*	Artist*	Album*	Song
Composer*	Album*	Song	—

For example: Searching by Artist name

The following example explains how an ARTIST search is performed. Another search mode can be used for the same operation, although the hierarchy differs.

1 Press Q/ESC to activate the search selection mode.

2 Turn the Rotary encoder to select the Artist search mode, and then press ▶/||/ENT.

Playlist ↔ Artist ↔ Album ↔ Song ↔ Podcast ↔ Genre ↔ Composer ↔ Playlist

3 Turn the Rotary encoder to select the desired Artist, and then press ▶/||/ENT.

4 Turn the Rotary encoder to select an album, and then press ▶/||/ENT.

5 Turn the Rotary encoder to select a song and press ►/||/ENT.

The selected song is played back.

- After pressing and holding ►/||/ENT for at least 2 seconds while in each hierarchy (except SONG hierarchy), all songs of the selected hierarchy are played back.
- After selecting [ALL] in the search mode with “*”, press and hold ►/||/ENT for at least 2 seconds to play back all songs in the iPod or selected search mode.
- While in the search mode, if you press and hold Q/ESC for at least 2 seconds, or no operation is performed for 10 seconds, the search mode is cancelled.
- In the search mode, pressing AUDIO/RTN will return to the previous mode.
- The search cannot be made during M.I.X. play.
- “NO SONG” will be displayed if there is no song in the selected playlist in the Playlist search mode.
- “NO PODCAST” will be displayed if there is no podcast data in the iPod in the PODCAST search mode.
- If “iPod name” stored in the iPod is selected in the desired Playlist search mode and ►/||/ENT is pressed, you can search for all songs in the iPod. Also, if you press and hold ►/||/ENT for at least 2 seconds, all songs in the iPod are played back.
- Depending on the iPod, podcast search is not supported.
- If any one of the preset buttons (1 through 6) is pressed in the search mode, a search can be made quickly by skipping to the specified location. For details, refer to “Direct Search Function” on page 30.

Quick Search

You can search a song from all songs in the iPod without selecting an album, artist, etc.

- 1 Press and hold Q/ESC for at least 2 seconds to activate the Quick Search mode.
- 2 Turn the Rotary encoder to select a desired song.
The selected song is played back immediately.

- Press and hold Q/ESC for at least 2 seconds in the search mode to cancel. Or, the search mode is cancelled if no operation is performed for 10 seconds.
- If many songs are in iPod, it takes time to search for songs.
- If any one of the preset buttons (1 through 6) is pressed in the search mode, a search can be made quickly by skipping to the specified location. For details, refer to “Direct Search Function” on page 30.

Direct Search Function

The unit’s direct search function can be used to search for an album, song, etc., more efficiently. In Playlist/Artist/Album/Song/Podcast/Genre/Composer mode, you can quickly target any song.

In the search mode, press any one of the preset buttons (1 through 6) to quickly skip over a designated percent of your song content.

Song search example:

If there are 100 songs in your iPod, they are divided into 6 groups using percentages (shown below). These groups are assigned to the preset buttons (1 through 6).

Example 1:

Suppose the song you are searching for is located at around the middle (50%) of your library; press button 4 to jump to the 50th song and turn the Rotary encoder to find the desired song.

Example 2:

Suppose the song you are searching for is located near the end (83%) of your library; press button 6 to jump to the 83rd song and turn the Rotary encoder to find the desired song.

	All 100 songs (100%)					
	0%	17%	33%	50%	67%	83%
Preset buttons	1	2	3	4	5	6
Songs	First song	17th song	33rd song	50th song	67th song	83rd song

Select Playlist/Artist/Album/Podcast/Genre/Composer

Playlist/Artist/Album/Podcast/Genre/Composer can be easily changed. For example, if you listen to a song from a selected album, the album can be changed.

Press ◀ or ▶ to select the desired Playlist/Artist/Album/Podcast/Genre/Composer.

- If the song search mode was used to select a song, this function is inactive.
- If an album is selected during an artist search, other albums by that artist are searchable.
- This function is inactive during shuffle (M.I.X.) playback.

Random Play Shuffle (M.I.X.)

The Shuffle function of the iPod is displayed as M.I.X. on this unit.

Shuffle Albums:



The songs on each album are played back in proper order. Upon completion of all the songs on the album, the next album is selected randomly. This continues until all albums have been played.

Shuffle Songs:

Song shuffle randomly plays back songs within a selected category (playlist, album, etc.). The songs within the category are played just once until all songs have been played.

1 Press 5 .

The songs are played back in random sequence.

M.I.X.  → M.I.X. → (off) → M.I.X. 
(Shuffle Albums) (Shuffle Songs)

2 To cancel M.I.X. play, select (off) with the above procedure.

- If a song is selected in the album search mode before selecting M.I.X. play, the songs will not play back randomly even when Shuffle Albums is selected.

Shuffle ALL:

Shuffle ALL plays all songs in the iPod randomly. Any one song does not play back again until all songs have been played back.

1 Press 6.

The songs are played back in random sequence.

M.I.X. → (off) → M.I.X.
(Shuffle ALL)

2 To cancel M.I.X. play, select (off) with the above procedure.

- If Shuffle ALL is selected, the selected songs being played back in the search mode are cancelled.

Repeat Play

Only Repeat One is available for the iPod.

Repeat One:



A single song is repeatedly played back.

1 Press 4.

The song is played back repeatedly.

RPT → (off) → RPT
(Repeat One)

2 To cancel repeat play, select (off) with the above procedure.

- During repeat playback, no other songs are selectable by pressing  or .

Displaying the Text

You can display the tag information of a song in the iPod.

Press TITLE.

Each press changes the display.

- If you want to change the display when the Text Scroll is set to Manual, press **TITLE** while the text is scrolling. If the scroll has been completed, press **TITLE** to scroll the text again.

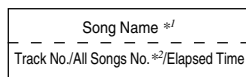
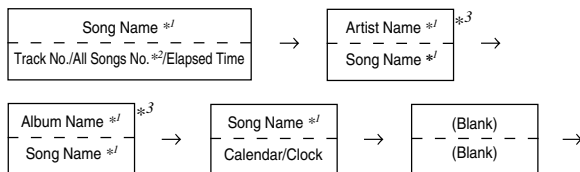

*1 TAG information

If the Scroll Setting (page 28) is set to "Auto", the tag information will scroll automatically.

If there is no text information, nothing will be displayed.

*2 The numbers of all songs displayed vary depending on the songs selected by the search.

*3 When the Scroll Setting (page 28) is set to "Auto", the display cannot be switched by pressing **TITLE**. The display contents switch alternately.

- Only alphanumeric characters (ASCII) can be displayed.
- If the artist, album or song name, created in iTunes, has too many characters, songs may not be played back when connected to the adapter. Therefore, a maximum of 250 characters is recommended. The maximum number of characters for the head unit is 128 (128 byte).
- Some characters may not be correctly displayed.
- The display is blank if text information is not supported by the unit.

Changer (Optional)

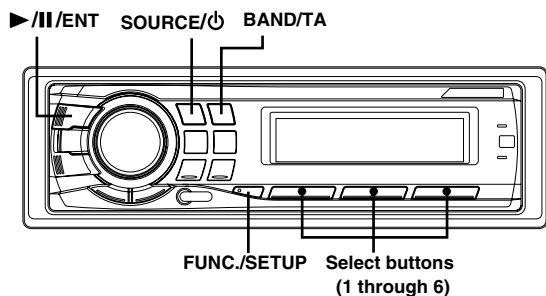

Controlling CD Changer (Optional)

An optional 6-disc or 12-disc CD Changer may be connected to this unit if it is Ai-NET compatible. With a CD Changer connected to the Ai-NET input of this unit, the CD Changer will be controllable from this unit.

Using the KCA-400C (Multi-Changer Switching device) or the KCA-410C (Versatile Link Terminal) multiple changers can be controlled by this unit.

See “Multi-Changer Selection (Optional)” on page 32 for selecting the CD Changers.

- The controls on this unit for CD Changer operation are operative only when a CD Changer is connected.
- The DVD changer (optional) is controllable from this unit as well as the CD changer.

1 Press SOURCE/⏻ to activate the CHANGER mode.
The display shows the disc number and track number.

- The source indicator varies depending on the connected source.
- Press BAND/TA to switch the Disc mode in the Changer mode.

2 Press FUNC./SETUP to activate the Disc selection mode.

Disc Select Mode (Disc No.1~6) → Disc Select Mode* (Disc No.7~12) →

RPT/M.I.X. Mode → Disc Select Mode (Disc No.1~6)

3 Press the disc select buttons (1 through 6) corresponding to one of the discs loaded in the CD Changer.

The selected disc number appears in the display and CD/MP3 playback starts.

- After selecting the desired disc, you can operate in the same way as for the CD player of this unit.
For details, please see the CD/MP3/WMA/AAC section.

* When a 12-disc CD changer is connected.

Playing MP3 Files with the CD Changer (Optional)

If you connect a changer compatible with MP3, you can play CD-ROMs, CD-Rs, and CD-RWs containing MP3 files on this unit.

- 1 Press SOURCE/⏻ to switch to the MP3 Changer mode.**
- 2 Press FUNC./SETUP to activate the disc selection mode.**

M.I.X./REPEAT operation mode → Disc selection mode → M.I.X./REPEAT operation mode

- 3 Press any one of the disc select buttons (1 through 6) corresponding to one of the discs loaded in the CD Changer.**

- 4 To pause playback, press >||/ENT.**
Pressing >||/ENT again will resume playback.

- The unit can play discs containing both audio data and MP3 data.
- For operating MP3 with an MP3 compatible CD Changer, refer to “CD/MP3/WMA/AAC” on pages 12 to 15.

Multi-Changer Selection (Optional)

Alpine’s Ai-NET system will support up to 6 CD Changers. When operating two or more changers, the KCA-400C (Multi-Changer Switching device) must be used. If you use 1 Switching device, you can connect up to 4 CD Changers. If you use 2 Switching devices, you can connect up to 6 CD Changers. When using KCA-410C (Versatile Link Terminal), you can connect two changers and two external outputs (AUX).

1 Press SOURCE/⏻ on this unit to activate the CD Changer mode.

2 Press BAND/TA to activate the CD Changer Selection mode.

The CD Changer Selection mode remains active for several seconds.

3 Press BAND/TA until the desired CD Changer indicator appears on the display.

- If the selected CD Changer is not connected, the display will show “NO CHANGER (No.)”.
- To operate the selected changer, see “CD/MP3/WMA/AAC” (pages 12-15).
- For further details about the external input (AUX) when using KCA-410C, see “Setting the AUX Mode (V-Link)” on page 25.

Remote Control

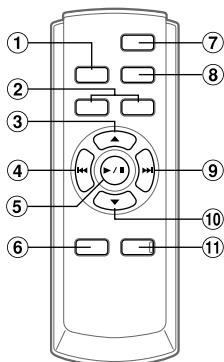

Controls on Remote Control

- ① **Source Button**
Press this button to select the audio source.
- ② **Volume Adjustment Buttons**
To increase the volume level:
Press the ▲ button

To decrease the volume level:
Press the ▼ button
- ③ **▲ Button**
Radio mode: Pressing this button will select, in ascending order, stations programmed into the radio's presets as shown below.
1 → **2** ... **6** → **1**
CD Changer mode: DISC Select (UP) button
Press this button to select a disc in ascending order.
MP3/WMA/AAC mode: Folder Select (UP) button
Press this button to select the folder.
MP3 compatible CD changer mode:
Folder Select (UP) / DISC Select (UP) button
Press this button to select a folder in ascending order. Press and hold this button to select a disc in ascending order.
iPod mode: Switches Playlist/Artist/Album.
- ④ **◀◀ DN Button**
Radio mode: SEEK (DN) Button
CD/iPod mode: Press this button to go back to the beginning of the current track.
- ⑤ **▶/|| Button**
Press this button to switch between the Play and Pause modes for CD.
- ⑥ **Audio Processor Button**
Each press of the button changes the audio processor mode.
For details, refer to "Operating the Audio Processor" as shown below.
Press the button to activate the external audio processor mode when the external audio processor is connected.*¹

*¹ For the operation of external audio processor, refer to the Owner's Manual of the external audio processor you purchased.

- ⑦ **Power Button**
Press this button to turn the power on/off.
- ⑧ **Band Button**
Radio mode: BAND Button
Press this button and the band will change.

Changer mode: To switch the changer.
- ⑨ **▶▶ UP Button**
Radio mode: SEEK (UP) button
CD/iPod mode: Press this button to advance to the beginning of the next track.
- ⑩ **▼ Button**
Radio mode: Pressing this button will select, in descending order, stations programmed into the radio's presets as shown below.
6 → **5** ... **1** → **6**
CD Changer mode: DISC Select (DN) button
Press this button to select a disc in descending order.
MP3/WMA/AAC mode: Folder Select (DN) button
Press this button to select the folder.

MP3 compatible CD changer mode:
Folder Select (DN) / DISC Select (DN) button
Press this button to select a folder in descending order.
Press and hold this button to select a disc in descending order.
iPod mode: Switches Playlist/Artist/Album.
- ⑪ **Mute Button**
Press this button to lower the volume by 20 dB instantly.
Press this button again to cancel.

Operating the Audio Processor

- 1 Press A.PROC to select the mode.**
Normal mode → T.CORR → X-OVER → Normal mode
- 2 Press ▲ or ▼ to select the item.**
Time Correction (T.CORR) mode/Crossover (X-OVER) mode:
Select from MEMORY 1 through 6.

Battery Replacement

Applicable battery: Use two "AAA" sized dry batteries or equivalent.

1 Opening the battery cover

Slide out the battery cover while firmly pressing in the direction of the arrow.

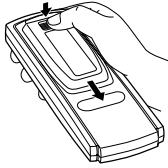

2 Replacing the battery

Insert the batteries, observing the polarities as illustrated.

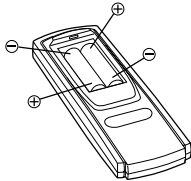

3 Closing the cover

Slide the cover as illustrated until a click is heard.

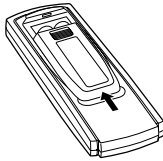

Controllable With Remote Control

Point the remote control transmitter at the remote control sensor.

Remote control sensor

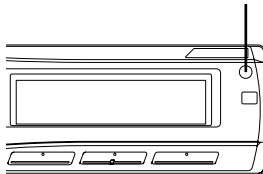

Connectable to Remote Control Interface Box

This unit may be controlled from the vehicle's audio controls. An optional Alpine Remote Control Interface Box must be used. For details, contact your Alpine dealer.

Information

In Case of Difficulty

If you encounter a problem, please turn the power off, then on again. If the unit is still not functioning normally, please review the items in the following checklist. This guide will help you isolate the problem if the unit is at fault. Otherwise, make sure the rest of your system is properly connected or consult your authorized Alpine dealer.

Basic

No function or display.

- Vehicle's ignition is off.
 - If connected following instructions, the unit will not operate with the vehicle's ignition off.
- Improper power lead (Red) and battery lead (Yellow) connections.
 - Check power lead and battery lead connections.
- Blown fuse.
 - Check the fuse of the unit; replace with the proper value if necessary.
- Internal micro-computer malfunctioned due to interference noise etc.
 - Press the RESET switch with a ballpoint pen or other pointed article.

Radio

Unable to receive stations.

- No antenna or open connection in cable.
 - Make sure the antenna is properly connected; replace the antenna or cable if necessary.

Unable to tune stations in the seek mode.

- You are in a weak signal area.
 - Make sure the tuner is in the DX mode.
- If the area you are in is a primary signal area, the antenna may not be grounded and connected properly.
 - Check your antenna connections; make sure the antenna is properly grounded at its mounting location.
- The antenna may not be the proper length.
 - Make sure the antenna is fully extended; if broken, replace the antenna with a new one.

Broadcast is noisy.

- The antenna is not the proper length.
 - Extend the antenna fully; replace it if it is broken.
- The antenna is poorly grounded.
 - Make sure the antenna is grounded properly at its mounting location.

CD

CD Player/Changer not functioning.

- Out of operating temperature range +50°C (+120°F) for CD.
 - Allow the vehicle's interior (or trunk) temperature to cool.

CD playback sound is wavering.

- Moisture condensation in the CD Module.
 - Allow enough time for the condensation to evaporate (about 1 hour).

CD insertion not possible.

- A CD is already in the CD player.
 - Eject the CD and remove it.
- The CD is being improperly inserted.
 - Make sure the CD is being inserted following instructions in the CD Player Operation section.

Unable to fast forward or backward the CD.

- The CD has been damaged.
 - Eject the CD and discard it; using a damaged CD in your unit can cause damage to the mechanism.

CD playback sound skips due to vibration.

- Improper mounting of the unit.
 - Securely re-mount the unit.
- The disc is very dirty.
 - Clean the disc.
- The disc has scratches.
 - Change the disc.
- The pick-up lens is dirty.
 - Do not use a commercially available lens cleaner disc. Consult your nearest Alpine dealer.

CD playback sound skips without vibration.

- The disc is dirty or scratched.
 - Clean the disc; damaged disc should be replaced.

Error displays (built-in CD player only).

- Mechanical error.
 - Press **▲**. After the error indication disappears, insert the disc again. If the above-mentioned solution does not solve the problem, consult your nearest Alpine dealer.

CD-R/CD-RW playback not possible.

- Close session (finalization) has not been performed.
 - Perform finalization and attempt playback again.

MP3/WMA/AAC

MP3, WMA or AAC is not played back.

- Writing error occurred. The CD format is not compatible.
 - Make sure the CD has been written in a supported format. Refer to "About MP3/WMA/AAC" (pages 14-15), then rewrite in the format supported by this device.

Audio

The sound is not output from the speakers.

- Unit has no output signal of the internal amplifier.
 - Power IC is switched to "ON" (page 26).

iPod

iPod does not play and no sound is output.

- The iPod has not been recognized.
 - Reset this unit and the iPod. Refer to "Initial System Start-Up" (page 7). To reset the iPod, refer to the Owner's Manual of the iPod.

Indication for CD Player

High Temperature

- Protective circuit is activated due to high temperature.
 - The indication will disappear when the temperature returns to normal operating range.

No Disc

- No CD is inserted.
 - Insert a CD.
- Although a disc is inserted, “No Disc” is displayed and the unit does not start to play or eject the disc.
 - Remove the disc by following these steps:
 - Press the **▲** button again for at least 2 seconds.
 - If the disc still does not eject, consult your Alpine dealer.

Error

- Mechanism error.
 - 1) Press the **▲** button and eject the CD.
 - If not ejecting, consult your Alpine dealer.
 - 2) When the error indication remains after ejecting, press the **▲** button again.
 - If the error indication still does not turn off after pressing the **▲** button for a few times, consult your Alpine dealer.
- *When “Error” is displayed:*
 - If the disc cannot be ejected by pressing **▲**, press the RESET switch (refer to page 7) and press **▲** again.*
 - If the disc still cannot be ejected, consult your Alpine dealer.*

PROTECT

- A copy-protected WMA file was played back.
 - You can only play back non-copy-protected files.

UNSUPPORTED

- A sampling rate/bit rate not supported by the unit is used.
 - Use a sampling rate/bit rate that is supported by the unit.

Indication for CD Changer

High Temperature

- Protective circuit is activated due to high temperature.
 - The indication will disappear when the temperature returns to normal operating range.

Error 01

- Malfunction in the CD Changer.
 - Consult your Alpine dealer. Press the magazine eject button and pull out the magazine.
 - Check the indication. Insert the magazine again.
 - If the magazine cannot be pulled out, consult your Alpine dealer.
- Magazine ejection not possible.
 - Press the magazine eject button. If the magazine does not eject, consult your Alpine dealer.

Error 02

- A disc is left inside the CD Changer.
 - Press the eject button to activate the eject function. When the CD Changer finishes the eject function, insert an empty CD magazine into the CD Changer to receive the disc left inside the CD Changer.

No Magazine

- No magazine is loaded into the CD Changer.
 - Insert a magazine.

No Disc

- No indicated disc.
 - Choose another disc.

Indication for iPod Mode

No iPod

- The iPod is not connected.
 - Make sure the iPod is correctly connected (refer to “Connections”).
 - Make sure the cable is not bent excessively.

NO SONG

- There are no songs in the iPod.
 - Download songs to the iPod and connect to the adapter.

NO PODCAST

- There is no podcast data in the iPod.
 - Download podcast data to the iPod and connect to this unit.

Error 01

- Communication error.
 - Turn the ignition key off, and then set to ON again.
 - Check the display by reconnecting between the iPod and this unit, using the iPod cable.

Error 02

- Caused by the iPod Software Version not being compatible with this unit.
 - Update the iPod Software Version to be compatible with this unit.

Specifications

FM TUNER SECTION

Tuning Range	87.5-108.0 MHz
Mono Usable Sensitivity	0.7 μ V
Alternate Channel Selectivity	80 dB
Signal-to-Noise Ratio	65 dB
Stereo Separation	35 dB
Capture Ratio	2.0 dB

MW TUNER SECTION

Tuning Range	531-1,602 kHz
Sensitivity (IEC Standard)	25.1 μ V/28 dB

LW TUNER SECTION

Tuning Range	153-281 kHz
Sensitivity (IEC Standard)	31.6 μ V/30 dB

CD PLAYER SECTION

Frequency Response	5-20,000 Hz (\pm 1 dB)
Wow & Flutter (% WRMS)	Below measurable limits
Total Harmonic Distortion	0.008% (at 1 kHz)
Dynamic Range	95 dB (at 1 kHz)
Signal-to-Noise Ratio	105 dB
Channel Separation	85 dB (at 1 kHz)

PICKUP

Wave length	795 nm
Laser power	CLASS I

GENERAL

Power Requirement	14.4 V DC (11-16 V allowable)
Maximum Power Output	60 W \times 4
Maximum Pre-Output Voltage	4 V/10 k ohms
Bass	+20/-14 dB at 60 Hz
Treble	\pm 14 dB at 10 kHz
Weight	1.7 kg (3 lbs. 11 oz)

CHASSIS SIZE

Width	178 mm (7")
Height	50 mm (2")
Depth	160 mm (6-1/4")

NOSEPIECE SIZE

Width	170 mm (6-3/4")
Height	46 mm (1-13/16")
Depth	24 mm (15/16")

- Due to continuous product improvement, specifications and design are subject to change without notice.

CAUTION

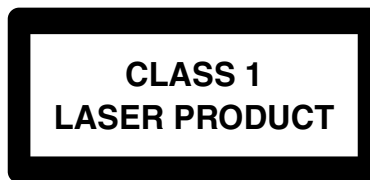

(Bottom side of player)

Installation and Connections

Before installing or connecting the unit, please read the following and pages 3 to 5 of this manual thoroughly for proper use.

Warning

MAKE THE CORRECT CONNECTIONS.

Failure to make the proper connections may result in fire or product damage.

USE ONLY IN CARS WITH A 12 VOLT NEGATIVE GROUND.

(Check with your dealer if you are not sure.) Failure to do so may result in fire, etc.

BEFORE WIRING, DISCONNECT THE CABLE FROM THE NEGATIVE BATTERY TERMINAL.

Failure to do so may result in electric shock or injury due to electrical shorts.

DO NOT SPLICE INTO ELECTRICAL CABLES.

Never cut away cable insulation to supply power to other equipment. Doing so will exceed the current carrying capacity of the wire and result in fire or electric shock.

DO NOT DAMAGE PIPE OR WIRING WHEN DRILLING HOLES.

When drilling holes in the chassis for installation, take precautions so as not to contact, damage or obstruct pipes, fuel lines, tanks or electrical wiring. Failure to take such precautions may result in fire.

DO NOT USE BOLTS OR NUTS IN THE BRAKE OR STEERING SYSTEMS TO MAKE GROUND CONNECTIONS.

Bolts or nuts used for the brake or steering systems (or any other safety-related system), or tanks should NEVER be used for installations or ground connections. Using such parts could disable control of the vehicle and cause fire etc.

KEEP SMALL OBJECTS SUCH AS BATTERIES OUT OF THE REACH OF CHILDREN.

Swallowing them may result in serious injury. If swallowed, consult a physician immediately.

DO NOT INSTALL IN LOCATIONS WHICH MIGHT HINDER VEHICLE OPERATION, SUCH AS THE STEERING WHEEL OR SHIFT LEVER.

Doing so may obstruct forward vision or hamper movement etc. and results in serious accident.

Caution

HAVE THE WIRING AND INSTALLATION DONE BY EXPERTS.

The wiring and installation of this unit requires special technical skill and experience. To ensure safety, always contact the dealer where you purchased this product to have the work done.

USE SPECIFIED ACCESSORY PARTS AND INSTALL THEM SECURELY.

Be sure to use only the specified accessory parts. Use of other than designated parts may damage this unit internally or may not securely install the unit in place. This may cause parts to become loose resulting in hazards or product failure.

ARRANGE THE WIRING SO IT IS NOT CRIMPED OR PINCHED BY A SHARP METAL EDGE.

Route the cables and wiring away from moving parts (like the seat rails) or sharp or pointed edges. This will prevent crimping and damage to the wiring. If wiring passes through a hole in metal, use a rubber grommet to prevent the wire's insulation from being cut by the metal edge of the hole.

DO NOT INSTALL IN LOCATIONS WITH HIGH MOISTURE OR DUST.

Avoid installing the unit in locations with high incidence of moisture or dust. Moisture or dust that penetrates into this unit may result in product failure.

Precautions

- Be sure to disconnect the cable from the (–) battery post before installing your CDA-9887R. This will reduce any chance of damage to the unit in case of a short-circuit.
- Be sure to connect the colour coded leads according to the diagram. Incorrect connections may cause the unit to malfunction or damage to the vehicle's electrical system.
- When making connections to the vehicle's electrical system, be aware of the factory installed components (e.g. on-board computer). Do not tap into these leads to provide power for this unit. When connecting the CDA-9887R to the fuse box, make sure the fuse for the intended circuit of the CDA-9887R has the appropriate amperage. Failure to do so may result in damage to the unit and/or the vehicle. When in doubt, consult your Alpine dealer.
- The CDA-9887R uses female RCA-type jacks for connection to other units (e.g. amplifier) having RCA connectors. You may need an adaptor to connect other units. If so, please contact your authorized Alpine dealer for assistance.
- Be sure to connect the speaker (–) leads to the speaker (–) terminal. Never connect left and right channel speaker cables to each other or to the vehicle body.

IMPORTANT

Please record the serial number of your unit in the space provided below and keep it as a permanent record. The serial number or the engraved serial number is located on the bottom of the unit.

SERIAL NUMBER: _____

INSTALLATION DATE: _____

INSTALLATION TECHNICIAN: _____

PLACE OF PURCHASE: _____

Installation

Caution

Do not block the unit's fan or heat sink, thus preventing air circulation. If blocked, heat will accumulate inside the unit and may cause a fire.

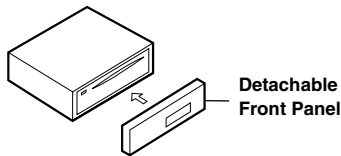
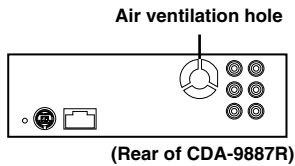

Caution

When you install this unit in your car, do not remove the detachable front panel. If the detachable front panel is removed during installation, you might press too hard and warp the metal plate that holds it in place.

- The main unit must be mounted within 35 degrees of the horizontal plane, back to front.

Less than 35°

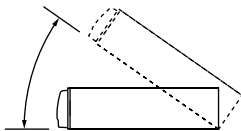

1

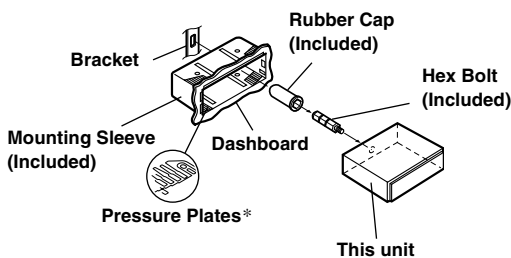

* If the installed mounting sleeve is loose in the dashboard, the pressure plates may be bent slightly to remedy the problem.

Remove the mounting sleeve from the main unit (see "Removal" on page 39). Slide the mounting sleeve into the dashboard and fix it with the metal shackles.

2

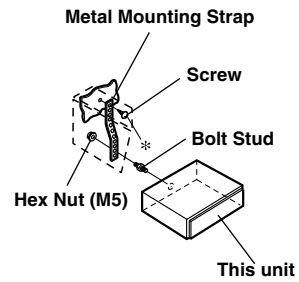

When your vehicle has the Bracket, mount the long hex bolt onto the rear panel of the CDA-9887R and put the Rubber Cap on the hex bolt. If your vehicle does not have the Mounting Support, reinforce the head unit with the metal mounting strap (not supplied). Connect all the leads of the CDA-9887R according to details described in the CONNECTIONS section.

- For the screw *, provide a proper screw to the chassis installing location.

3

Slide the CDA-9887R into the dashboard. When the unit is in place, make sure the locking pins are fully seated in the down position. This can be done by pressing firmly in on the unit while pushing the locking pin down with a small screwdriver. This ensures that the unit is properly locked and will not accidentally come out from the dashboard.

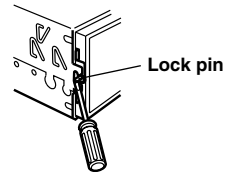

Removal

- Remove the detachable front panel.
- Use a small screwdriver (or similar tool) to push the locking pins to the "up" position (see above drawing). As each pin is unlocked, gently pull out on the unit to make sure it does not re-lock before unlocking the second pin.
- Pull the unit out, keeping it unlocked as you do so.

<JAPANESE CAR>

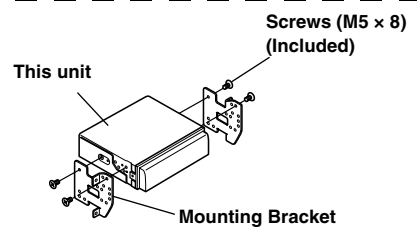
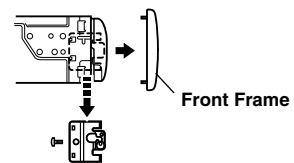

Connections

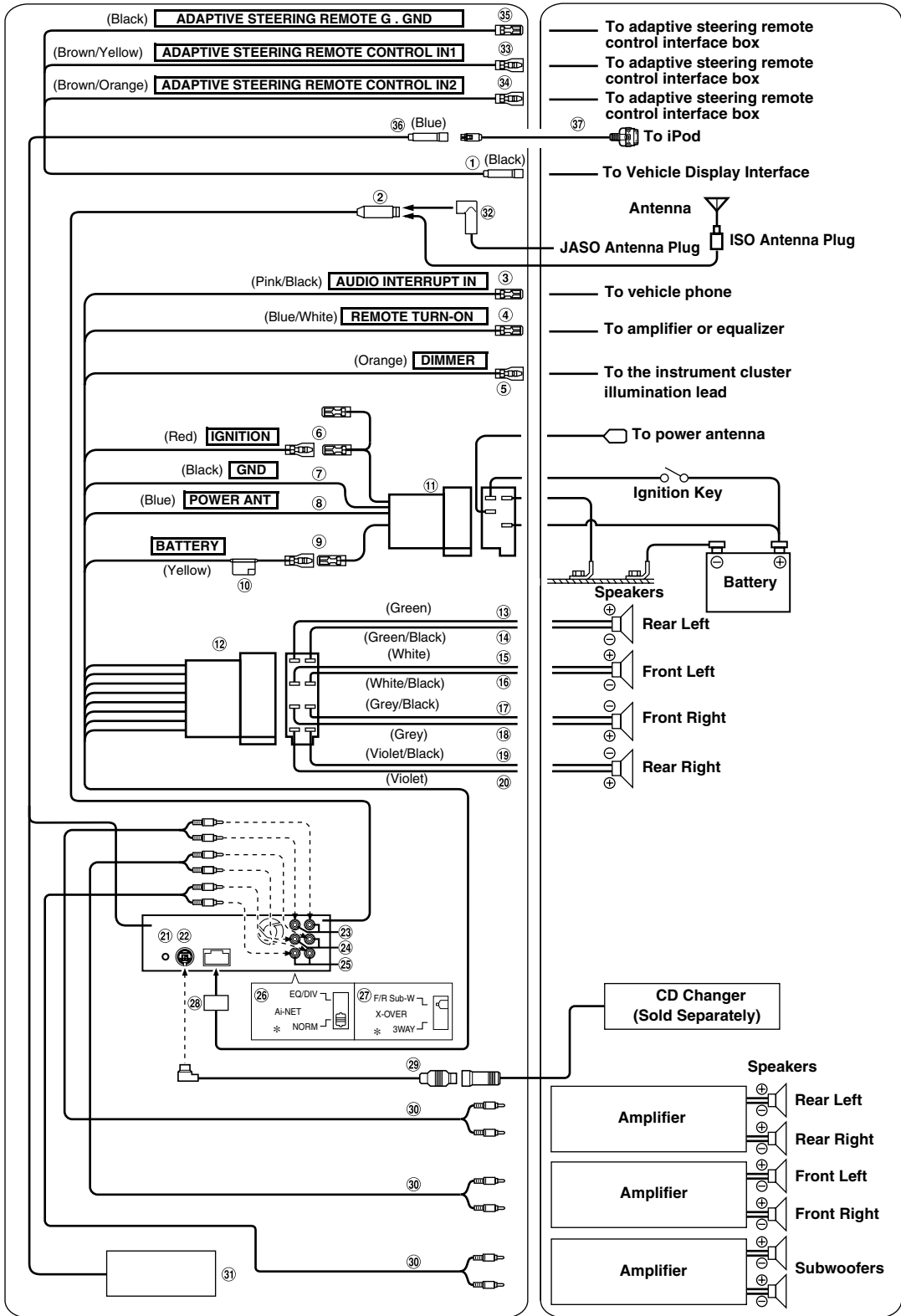

* The label is attached on the bottom of the unit.

- ① **Vehicle Display Interface Connector (Black)**
Outputs Vehicle Display Interface control signals. Connect this to the optional Vehicle Display Interface box. For details about connections, consult your nearest Alpine dealer.
 - ② **Antenna Receptacle**
 - ③ **Audio Interrupt In Lead (Pink/Black)**
Connect this lead to the Audio Interface output of a cellular phone which provides ground shorting when a call is received.
 - ④ **Remote Turn-On Lead (Blue/White)**
Connect this lead to the remote turn-on lead of your amplifier or signal processor.
 - ⑤ **Dimmer Lead (Orange)**
This lead may be connected to the vehicle's instrument cluster illumination lead. This will enable the vehicle's dimmer control to dim the backlighting of the unit.
 - ⑥ **Switched Power Lead (Ignition) (Red)**
Connect this lead to an open terminal on the vehicle's fuse box or another unused power source which provides (+) 12V only when the ignition is turned on or in the accessory position.
 - ⑦ **Ground Lead (Black)**
Connect this lead to a good chassis ground on the vehicle. Make sure the connection is made to bare metal and is securely fastened using the sheet metal screw provided.
 - ⑧ **Power Antenna Lead (Blue)**
Connect this lead to the +B terminal of your power antenna, if applicable.
 - *This lead should be used only for controlling the vehicle's power antenna. Do not use this lead to turn on an amplifier or a signal processor, etc.*
 - ⑨ **Battery Lead (Yellow)**
Connect this lead to the positive (+) post of the vehicle's battery.
 - ⑩ **Fuse Holder (15 A)**
 - ⑪ **ISO Power Supply Connector**
 - ⑫ **ISO Connector (Speaker Output)**
 - ⑬ **Left Rear (+) Speaker Output Lead (Green)**
 - ⑭ **Left Rear (-) Speaker Output Lead (Green/Black)**
 - ⑮ **Left Front (+) Speaker Output Lead (White)**
 - ⑯ **Left Front (-) Speaker Output Lead (White/Black)**
 - ⑰ **Right Front (-) Speaker Output Lead (Grey/Black)**
 - ⑱ **Right Front (+) Speaker Output Lead (Grey)**
 - ⑲ **Right Rear (-) Speaker Output Lead (Violet/Black)**
 - ⑲ **Right Rear (+) Speaker Output Lead (Violet)**
 - ⑳ **Steering Remote Control Interface Connector**
To steering remote control interface box. For details about connections, consult your nearest Alpine dealer.
 - ㉑ **Ai-NET Connector**
Connect this to the output or input connector of other product (CD changer, Equalizer, etc.) equipped with Ai-NET.
 - ㉒ **Rear Output RCA Connectors**
RED is right and WHITE is left.
 - ㉓ **Front Output RCA Connectors**
RED is right and WHITE is left.
 - ㉔ **Subwoofer Output RCA Connectors**
RED is right and WHITE is left.
 - ㉕ **System Switch**
When connecting a processor using Ai-NET, place this switch in the EQ/DIV position. When no device is connected, leave the switch in the NORM position.
 - *Be sure to turn the power off to the unit before changing the switch position.*
 - ㉖ **Setting the 2.2ch (3WAY)/4.2ch (F/R/Sub-W) switch**
Set the 2.2ch (3WAY)/4.2ch (F/R/Sub-W) Switch according to your audio system.
 - ㉗ **Power Supply Connector**
 - ㉘ **Ai-NET Cable (Included with CD Changer)**
 - ㉙ **RCA Extension Cable (sold separately)**
 - ㉚ **DC/DC Converter**
 - *Do not install the converter at a location subjected to water such as under the floor mat or air conditioner. This may cause a malfunction.*
 - *Do not bundle the DC/DC converter cable with other audio cables. Doing so may induce noise into your system.*
 - *Keep the DC/DC converter away from the Antenna cables and the rear side of the unit, otherwise noise may be generated when receiving radio broadcast.*
 - ㉛ **ISO/JASO Antenna Adaptor (sold separately)**
An ISO/JASO antenna adaptor may be required, depending on the vehicle.
 - ㉜ **Adaptive Steering Remote Control In 1 Lead (Brown/Yellow)**
To adaptive steering remote control interface box. For details about connections, consult your nearest Alpine dealer.
 - ㉝ **Adaptive Steering Remote Control In 2 Lead (Brown/Orange)**
To adaptive steering remote control interface box. For details about connections, consult your nearest Alpine dealer.
 - ㉞ **Adaptive Steering Remote G.GND**
To adaptive steering remote control interface box. For details about connections, consult your nearest Alpine dealer.
 - ㉟ **iPod Direct Connector (Blue)**
Control iPod signals. Connect this to an iPod or to an optional Bluetooth Box. To use a hands-free mobile phone, an optional Bluetooth Box connection is required. For details on connection, refer to the Owner's Manual of the Bluetooth Box. You can also connect this to an external device (such as a portable player) by using iPod Direct/RCA Interface cable (sold separately).
- * Refer to "Setting the AUX+ Setup Mode" (page 25).
- AUX+ ON : When the external device is connected.
AUX+ OFF : When an iPod is connected.
- ㊱ **FULL SPEED™ Connection Cable (KCE-422i) (sold separately)**

The X-Over Switch position for a 4.2ch system (frequency range is divided between highs for front/rear and lows for the Subwoofer).

The position of the X-Over switch: F/R/Sub-W

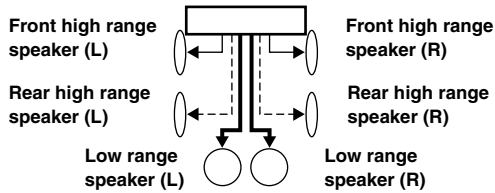

The X-Over Switch position for a 2.2ch system whose frequency range is divided among the highs (Rear), mids (Front), and lows (Subwoofer).

The position of the X-Over switch: 3WAY

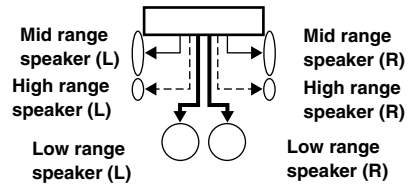

Output of this unit:

————— Front output

----- Rear output

————— SUB-W output

- Use the Sub-W output cord to connect the unit to the low range speaker.
- You can use the built-in amplifier to output the front output/rear output.
- You cannot adjust the fader when set to 3WAY.

To prevent external noise from entering the audio system.

- Locate the unit and route the leads at least 10 cm away from the car harness.
- Keep the battery power leads as far away from other leads as possible.
- Connect the ground lead securely to a bare metal spot (remove any paint, dirt or grease if necessary) of the car chassis.
- If you add an optional noise suppressor, connect it as far away from the unit as possible. Your Alpine dealer carries various noise suppressors, contact them for further information.
- Your Alpine dealer knows best about noise prevention measures so consult your dealer for further information.



Car Audio and Navigation Systems

GERÄTE-PASS

AUDIO SYSTEME

Fahrzeugmarke: _____ Typ: _____

Amtl. Kennzeichen: _____

Name des Halters: _____

Straße: _____

Wohnort: _____

Bitte füllen Sie diesen Pass vollständig aus und bewahren Sie ihn außerhalb des Fahrzeugs auf:

Im Falle eines Diebstahls wird für Sie die Schadensabwicklung mit der Versicherung einfacher, und Sie erleichtern der Polizei die Fahndung nach den Tätern.

Appendix

Product Information Card

Produkt-Informationskarte

Carte d'informations sur le produit

Tarjeta de información del producto

English

Filling in this Product Information Card is voluntary. If you fill in this card and send it to Alpine, your data will be tabulated into reference data for future Alpine product development. In addition, in the future you may receive information about new products or Survey Mail requesting additional opinions about Alpine products or services. If you agree to the above term, please sign your name in the indicated space and return the card. Any additional comments or inquiries may be sent to : Person in charge of Customer Service department Alpine Electronics (Europe) GmbH.
Frankfurter Ring 117, 80807 München, Germany
Phone: +49-(0)89-32 42 640

Deutsch

Das Ausfüllen dieser Produktinformations-Karte ist freiwillig. Sollten Sie diese Karte vervollständigen, so werden die Daten für zukünftige Produktentwicklungen von Alpine als Referenzdaten herangezogen. Ebenso können Sie in der Zukunft Informationen über neue Alpine Produkte erhalten oder uns auch Ihre Meinung über Alpine Produkte und Dienstleistungen im Rahmen von Kunden-Befragungen mitteilen. Stimmen Sie dem Kontakt durch Alpine zu, so würden wir Sie bitten, in dem dafür vorgesehenen Feld zu unterschreiben und die Karte kostenfrei an uns zurückzuschicken. Zusätzliche Kommentare und Meinungen können Sie gerne an den zuständigen Kontakt im Kundendienst Alpine Electronics (Europe) GmbH senden.
Frankfurter Ring 117, 80807 München, Germany
Phone: 089-32 42 640

Français

En remplissant volontairement cette fiche, et en l'envoyant à Alpine, vous acceptez que ces informations soient utilisées par Alpine, dans le cadre de développement de nouveaux produits. Par ailleurs, vous autorisez Alpine à solliciter votre opinion par mailing sur de nouveaux produits ou services. Si vous acceptez les termes ci-dessus, veuillez signer cette carte à l'endroit indiqué, et nous la retourner. Tout autre commentaire ou demande doit être adressé à l'attention de: Responsable du service consommateur Alpine Electronics (Europe) GmbH.
Frankfurter Ring 117, 80807 München, Germany
Phone: +49-(0)89-32 42 640

Español

El envío de la información solicitada es voluntario. Si Vd. nos la remite, será utilizada de modo confidencial para el desarrollo de futuros productos Alpine. Si Vd. desea recibir información sobre nuevos productos de nuestra gama, indique su nombre en el espacio designado y remitanos la tarjeta. Cualquier solicitud adicional puede ser enviada a : Persona responsable del Servicio de Atención al Cliente de Alpine Electronics (Europe) GmbH.
Frankfurter Ring 117, 80807 München, Germany
Phone: +49-(0)89-32 42 640

Q1. PRODUCT PURCHASED

1. Cassette Player
2. CD Player
3. MD Player
4. DVD Player
5. CD Changer
6. Amplifier
7. Speaker
8. Subwoofer
9. Monitor Controller
10. Video Monitor
11. Navigation
12. Processor/Equalizer
13. CD/Video CD Changer
14. Other_____

Q2. MODEL NUMBER:_____

Q3. DATE OF PURCHASE:

Month:_____Year:_____

Q4. If navigation system, which monitor?

1. Alpine → (Model No.)_____
2. Other → (Brand Name)_____

Q5. STORE TYPE WHERE PURCHASED:

1. Car Audio Specialist
2. Audio/Video Store
3. Electronics/Appliance Store
4. Car Accessories Shop
5. Other_____

Q6. Type of vehicle in which this unit is installed:

Make:_____ Model:_____

Purchased Model

Year:_____ Year:_____

Q7. How was this vehicle purchased?

1. Purchase
2. Lease

Q8. Purpose of buying this unit?

1. Addition
 2. Replacement
- ↓
- Previous brand replaced?
1. Factory installed
 2. Alpine
 3. Other → (Brand Name)_____

Q9. Have you purchased Alpine products before?

1. First time
2. Two or More times

Q10. When you purchased this Alpine unit, did you compare it with other brand?

1. Yes → (Brand Name)_____
2. No.

Q11. GENDER

1. Male
2. Female

Q12. AGE

Q13. MARITAL STATUS

1. Single
2. Married

Q14. OCCUPATION

1. Company Owner/Self-employed/Freelance
2. Manager
3. Company Employee
4. Civil Servant
5. Educator
6. Student
7. Other_____

Q15. Comments_____

Q1. gekauftes Gerät

1. Kassetten-Spieler
2. CD-Spieler
3. MD-Spieler
4. DVD-Spieler
5. CD-Wechsler
6. Verstärker
7. Lautsprecher
8. Subwoofer
9. Monitor-Controller
10. Video-Monitor
11. Navigationssystem
12. Prozessor/Equalizer
13. CD/Video-CD-Wechsler
14. andere_____

Q2. Modellnummer:_____

Q3. Kaufdatum:

Monat:_____Jahr:_____

Q4. Falls Navigationssystem: Welcher Monitor?

1. Alpine → (Modellnr.)_____
2. Anderer Hersteller → (Herstellername)_____

Q5. Art des Geschäfts, in dem Sie das Gerät gekauft haben:

1. Spezialist für Auto-Audioanlagen
2. Audio/Video-Geschäft
3. Elektro-Geschäft
4. Autzubehör-Geschäft
5. Anderer Hersteller_____

Q6. Art des Fahrzeugs, in das das Gerät installiert wurde:

Marke:_____Modell:_____

gekauft im

Jahr:_____Baujahr:_____

Q7. Wie haben Sie das Fahrzeug gekauft?

1. Kauf
2. Leasing

Q8. Zweck des Kaufs dieses Geräts?

1. Zusätzlich
 2. Austausch
- ↓
- Marke des ausgetauschten Geräts?
1. Serienmäßige Ausstattung
 2. Alpine
 3. Anderer Hersteller → (Herstellername)_____

Q9. War dies das erste Mal, dass Sie ein Alpine-Gerät gekauft haben?

1. Erstes Mal
2. Zweites Mal oder öfter

Q10. Haben Sie dieses Alpine-Gerät vor dem Kauf mit Geräten anderer Hersteller verglichen?

1. Ja → (Herstellername)_____
2. Nein

Q11. Geschlecht

1. Männlich
2. Weiblich

Q12. Alter

Q13. Familienstand

1. Ledig
2. Verheiratet

Q14. Beruf

1. Selbständige/Firmeninhaber/freiberuflich Tätige
2. Leitende Angestellte
3. Sonstige Angestellte
4. Beamte
5. Schulbildung
6. Studium
7. Sonstige_____

Q15. Kommentar:_____

Q1. PRODUIT ACHETE

1. Lecteur de cassette
2. Lecteur de CD
3. Lecteur MD
4. Lecteur DVD
5. Changeur de CD
6. Amplificateur
7. Haut-parleur
8. Haut-parleur de graves
9. Station Multimedia
10. Moniteur Vidéo
11. Navigation
12. Processeur/Equaliseur
13. Changeur de CD/CD Vidéo
14. Autre_____

Q2. NUMERO DU MODELE:_____

Q3. DATE D'ACHAT:

Mois:_____Année:_____

Q4. Si c'est un système de navigation, quel moniteur?

1. Alpine → (N° du modèle)_____
2. Autre → (Marque)_____

Q5. TYPE DE MAGASIN OU VOUS AVEZ ACHETE LE PRODUIT:

1. Spécialiste autoradio
2. Magasin audio/vidéo
3. Magasin d'électronique/appareils
4. Magasin d'accessoires automobiles
5. Autre_____

Q6. Type de véhicule dans lequel cet appareil est installé:

Marque:_____Modèle:_____

Année _____ Année du

d'achat:_____modèle:_____

Q7. Comment avez-vous acheté ce véhicule?

1. Achat
2. Location-bail

Q8. Pourquoi avez-vous acheté cet appareil?

1. Addition
 2. Remplacement
- ↓
- Marque précédente remplacée?

1. Installée en usine
2. Alpine
3. Autre → (Marque)_____

Q9. Avez-vous déjà acheté des produits Alpine?

1. Première fois
2. Deux fois ou plus

Q10. Lorsque vous avez acheté ce produit Alpine, l'avez-vous comparé à une autre marque?

1. Oui → (Marque)_____
2. Non

Q11. SEXE

1. Masculin
2. Féminin

Q12. AGE

Q13. SITUATION DE FAMILLE

1. Célibataire
2. Marié

Q14. PROFESSION

1. Entrepreneur/Travailleur indépendant/Freelance
2. Directeur
3. Employé de bureau
4. Fonctionnaire
5. Educateur
6. Etudiant
7. Autre_____

Q15. Commentaires_____

Q1. Producto Comprado

1. Radio/Cassette
2. Radio/CD
3. Reproductor de MD
4. Reproductor de DVD
5. Cambiador de CD
6. Amplificador
7. Altavoz
8. Subwoofer
9. Monitor de control
10. Monitor de video
11. Sistema de navegación
12. Procesador/Equalizador
13. Cambiador de CD/Video CD
14. Otros_____

Q2. Número de modelo:_____

Q3. Fecha de compra:

Mes:_____Año:_____

Q4. En caso de sistema de navegación, ¿qué monitor?

1. Alpine → (N° de modelo)_____
2. Otros → (Nombre de marca)_____

Q5. TIPO DE TIENDA DONDE COMPRÓ:

1. Especialista en audio de automóviles
2. Tienda de audio/video
3. Tienda de electrónica/electrodomésticos
4. Tienda de accesorios automovilísticos
5. Otros_____

Q6. Tipo de vehículo en que la unidad está instalada:

Marca:_____Modelo:_____

Año de compra:_____ Año del

modelo:_____

Q7. ¿Cómo fue comprado este vehículo?

1. compra
2. Leasing

Q8. ¿Propósito de comprar esta unidad?

1. Mejora del sistema
 2. Sustitución
- ↓
- ¿Sustitución de marca anterior?

1. Instalado en la fábrica
2. Alpine
3. Otros → (Nombre de marca)_____

Q9. ¿Ha comprado Vd. productos Alpine anteriormente?

1. Primera vez
2. Dos o más veces

Q10. Cuando usted compró esta unidad Alpine, ¿la comparó con otros fabricantes?

1. Si → (Nombre de marca)_____
2. No

Q11. SEXO

1. Masculino
2. Femenino

Q12. Edad

Q13. Estado civil

1. Soltero
2. Casado

Q14. Ocupación

1. Propietario de empresa/Autónomo/ Profesional independiente
2. Gerente
3. Empleado de compañía
4. Empleado público
5. Profesor
6. Estudiante
7. Otros_____

Q15. Comentarios_____

Scheda informazioni prodotto

Italiano

La compilazione di questo formulario è volontaria. Se compilate questo formulario, ritornandolo ad Alpine, i Vostri dati saranno raccolti in un file di riferimento per lo sviluppo dei nuovi prodotti Alpine. In aggiunta Voi potrete ricevere in futuro informazioni riguardanti i nuovi prodotti o la richiesta di una Vostra opinione circa i prodotti o i servizi forniti da Alpine. Se siete d'accordo, Vi preghiamo di ritornarci il formulario completato negli appositi spazi con i Vostri dati. In caso desideriate fornire altri commenti o richiedere informazioni aggiuntive, potete indirizzare il tutto a :
 Responsabile dipartimento Servizio Clienti Alpine Electronics (Europe) GmbH.
 Frankfurter Ring 117, 80807 München, Germany
 Phone: +49-(0)89-32 42 640

Q1. PRODOTTO ACQUISTATO

1. Lettore di cassette
2. Lettore CD
3. Lettore MD
4. Lettore DVD
5. CD Changer
6. Amplificatore
7. Altoparlante
8. Subwoofer
9. Radio Monitor
10. Monitor video
11. Sistema di navigazione
12. Processore/equalizzatore
13. Cambia CD/Video CD
14. Altro _____

Q2. NUMERO MODELLO: _____

Q3. DATA DI ACQUISTO:

Mese: _____ Anno: _____

Q4. In caso di acquisto di un sistema di navigazione, quale monitor possiede?

1. Alpine → (No. Modello) _____
2. Altro → Nome marca _____

Q5. NEGOZIO DI ACQUISTO:

1. Specialista Car Stereo
2. Negozio di audio/video
3. Negozio di elettronica/elettrodomestici
4. Negozio accessori automobile
5. Altro _____

Q6. Tipo di veicolo posseduto:

Marca: _____ Modello: _____
 Anno _____ Anno _____
 acquisto: _____ modello: _____

Q7. Modalità acquisto

1. Acquisto
2. Leasing

Q8. Scopo acquisto

1. Aggiunta
2. Sostituzione

- ↓
- * Marca sostituita
 - 1. Installato di fabbrica
 - 2. Alpine
 - 3. Altro → (Nome marca) _____

Q9. Avevate già acquistato prodotti Alpine?

1. No
2. Due o tre volte

Q10. Nell'acquistarlo, avete paragonato questo prodotto ad un'altra marca?

1. Sì → (Nome marca) _____
2. No

Q11. SESSO

1. Maschile
2. Femminile

Q12. ETÀ _____

Q13. STATO CIVILE

1. Celibe/nubile
2. Coniugato/coniugata

Q14. LAVORO

1. Proprietario di azienda/artigiano/libero professionista
2. Manager
3. Impiegato
4. Impiegato statale
5. Insegnante
6. Studente
7. Altro _____

Q15. Commenti _____

◆ I agree to the above stated terms of the Alpine Product Information Card.
 ◆ Ich stimme dem Kontakt durch Alpine für Informations- und Befragungszwecke zu.
 ◆ J'accepte les termes de cette carte d'information produit Alpine.
 ◆ Estoy conforme con los términos de la tarjeta de información sobre producto de Alpine.
 ◆ Accetto i termini della scheda informazioni prodotti Alpine.

_____ (Date/Datum/Date/Fecha/Data)

_____ (Signature/Unterschrift/Signature/Firma)

Name/Nom/Nombre/Nome

(First Name/Vorname/Prénom/Primer nombre/Nome)

(Surname/Familiennome/Nom de famille/Apellido/Cognome)

Home Address/Privatanschrift/Adresse/Dirección/Indirizzo

(Street/Straße/Rue/Calle/Via) (Post Code/Postleitzahl/Code postal/Código postal/Codice postale)

(Town/City/Stadt/Ville/Ciudad/Città) (Country/Land/Pays/Pais/Paese)

Telephone Number: _____

E-Mail/Correo electrónico: _____

Q1 NO. _____
 Other _____

Q2 _____

Q3 Month _____ Year _____

Q4 NO.1. Model No. _____
 NO.2. Brand Name _____

Q5 NO. _____
 Other _____

Q6 Make: _____ Model: _____
 Purchased Year: _____ Model Year: _____

Q7 NO. _____

Q8 NO. 1 Previous brand replaced. Brand Name _____
 2 1. 2. 3.

Q9 NO. _____

Q10 1 Brand Name _____
 NO. 2 _____

Q11 NO. _____

Q12 _____ years old

Q13 NO. _____

Q14 NO. _____
 Other _____

Q15 Comments _____

S/NO. LABEL

NE PAS AFFRANCHIR

NICHT FREIMACHEN
NO STAMP REQUIRED

REPOSE PAYEE/ WERBEANTWORT
ALLEMAGNE

ALPINE ELECTRONICS (EUROPE) GmbH
Frankfurter Ring 117, 80807 München,

Germany

LUFTPORT
PAR AVION
PRIORITAIRE